

Perar

Trunnion Mounted Ball Valves



Perar
**THAT'S
QUALITY**

The Best Guarantee of Safety

Perar Ball Valves, One of the first.... since 1962

Founded in 1962, Perar is one of the first Italian Manufacturers of High Quality Ball Valves. The development of the company started as leading supplier in Gas Industry, all over the domestic market.

In the following years, Perar, has experienced a continuous and steady growth in the areas of world-wide sales, production capacity, efficiency and technological development.

Perar today is one of the leading Italian manufacturers of High Quality Industrial Valves for a wide variety of applications in various fields like Oil, Gas, Petrochemical, On-Off Shore, Heavy Chemicals, and over...



Perar production includes Ball Valves in sizes from 1/2" to 60". Ansi classes 150 to 2500 and Api 2000 to Api 20000, in Carbon Steel, Stainless Steel, Duplex Steel, Super Duplex Steel, Alloy Steel, Incoloy, Monel, 6Mo, Titanium, and various others...

The construction available are:

- Floating Design
- Trunnion Mounted Side Entry
- Trunnion Mounted Top Entry
- Metal Seated
- Sub-sea and Cryogenic
- Bolted and Fully-Welded Body.





Perar Product Range

Trunnion Mounted Side-Entry Ball Valves

Side-Entry Ball Valves represent the basic design standard of PERAR trunnion mounted valves covering a wide range of sizes and pressure classes.

General characteristics:

- 2 or 3 pieces side entry design with trunnion mounted or support plate configuration
- Design per API 6D or API 6A
- Full Bore and Reduced Bore design
- Flanged, Welding or Hub Ends
- Bi-directional sealing
- Fire-safe design



Model: EC
Size: 1/2" to 4"
Pressure Classes: ASME 150# to 2500#
API 6A 3000 to 15000
Temp. Range: -196°C to 400°C

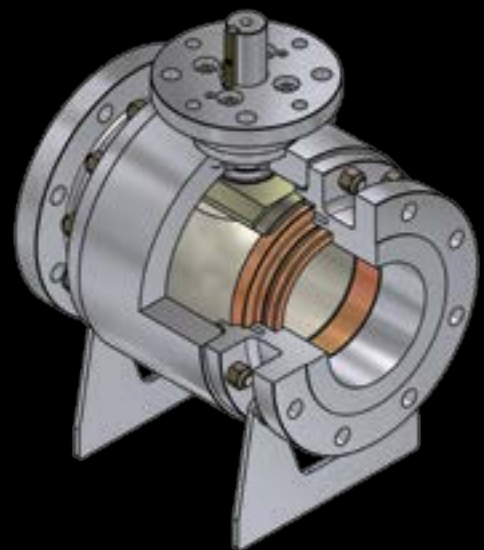

Model: EB
Size: 4" to 68"
Pressure Classes: ASME 150# to 2500#
API 6A 3000 to 15000
Temp. Range: -196°C to 400°C



Perar Product Range

Trunnion Mounted Welded Body Ball Valves

The design of PERAR Welded Body Ball Valves minimizes the potential leak paths making these valves suitable for buried installations and in general for gas transportation.

General characteristics

- Design per API 6D or API 6A
- Full Bore and Reduced Bore design
- Flanged or Welding Ends
- Bi-directional sealing
- Fire-safe design

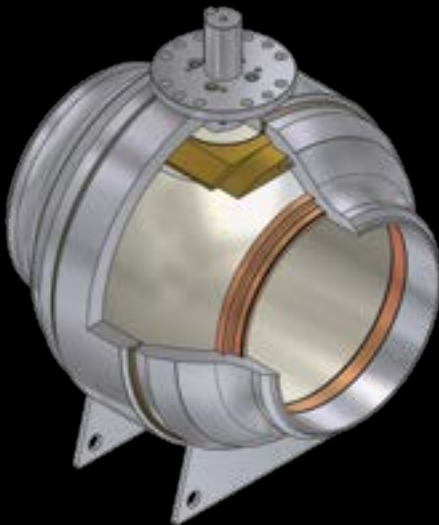

Model: WB
Size: 1/2" to 68"
Pressure Classes: ASME 150# to 2500#
Temperature Range: -196°C to 400°C

Trunnion Mounted Top-Entry Ball Valves

PERAR Trunnion Mounted Top-Entry Ball Valves add a full in-line maintenance capability to the advantages of a trunnion mounted construction.

General characteristics

- Design per API 6D or API 6A
- Full Bore and Reduced Bore design
- Flanged, Welding or Hub Ends
- Bi-directional sealing
- Fire-safe design



Model: TE
Size: 1/2" to 68"
Pressure Classes: ASME 150# to 2500#
API 6A 3000 to 15000
Temperature Range: -196°C to 400°C





Perar Design Features - Side Entry Ball Valves

2 or 3 pieces side entry design with trunnion mounted or support plate configuration for smooth and low torque operations

Drive train mechanism sized to safely withstand the maximum torque loads exerted by the different operating systems



Forged body and end adaptors

Different end types available (flanged, welded, hubs, etc.) in compliance with the main international codes

Hard-faced metal seated design is an option to the standard soft insert seat-to-ball sealing system

Perar Design Features - Side Entry Ball Valves

2 or 3 pieces side entry design with support plate configuration for smooth and low torque operations

Body welded construction for minimizing potential leak paths.



Forged body and end adaptors

Body shaped configuration for size and weight optimization



Perar Design Features - Top Entry Ball Valves

Top-entry design with upper bolted bonnet for full in-line maintainability welded construction for minimizing potential leak paths



Shaped cast body for size and weight optimization



Perar - Technical Features

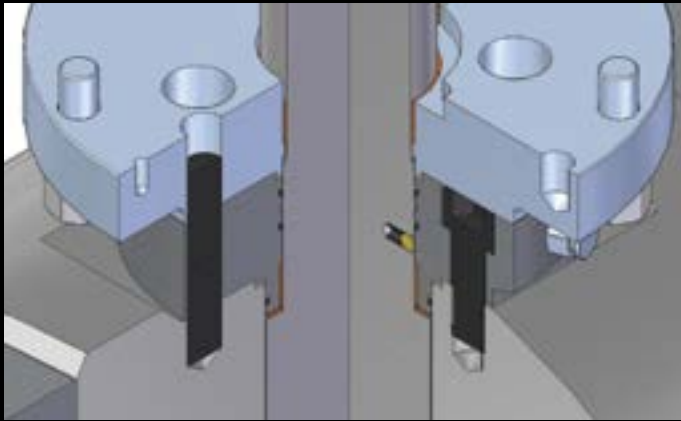

ANTI-BLOW OUT STEM DESIGN

The stem retention is obtained through a shouldered design which is kept in place by the top bolted cover, thus not relying on possible packing gland or operator components.

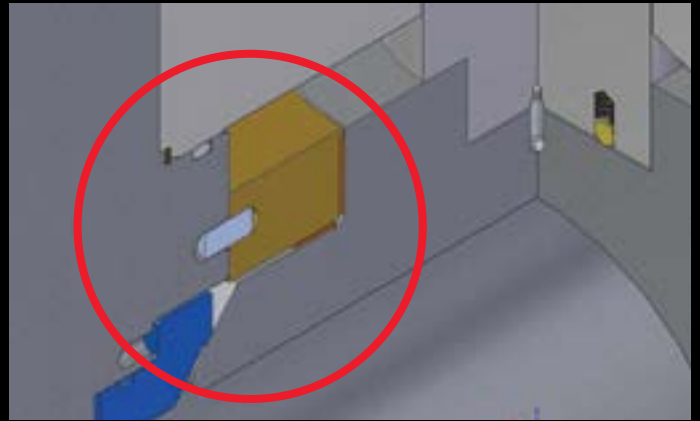

HEAVY DUTY BEARINGS

Heavy duty PTFE coated steel bearings are mounted on trunnions granting low friction with no need of periodic lubrication.

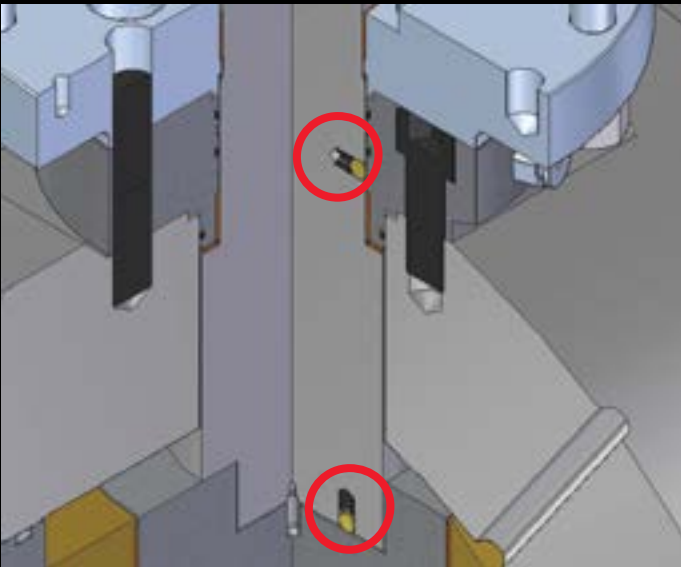

ANTISTATIC DEVICE

The electrical continuity between all metallic components of body and trim is granted by a spring loaded device.

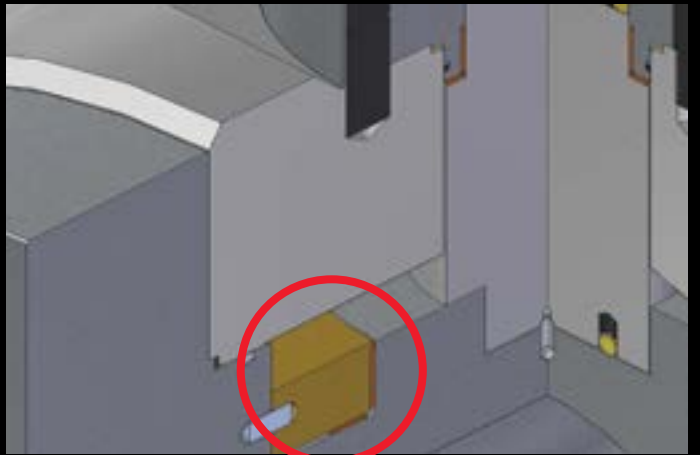

PRESSURE BOUNDARY SEALING SYSTEM

A double barrier composed by an O-ring and a graphite gasket grant a perfect sealing together with fire safety at static joints between the pressure boundary parts making PERAR ball valves suitable for both topside and buried installations.

Different seal types (e.g. spring energised lip-seals) are available for special service conditions.



Perar - Technical Features

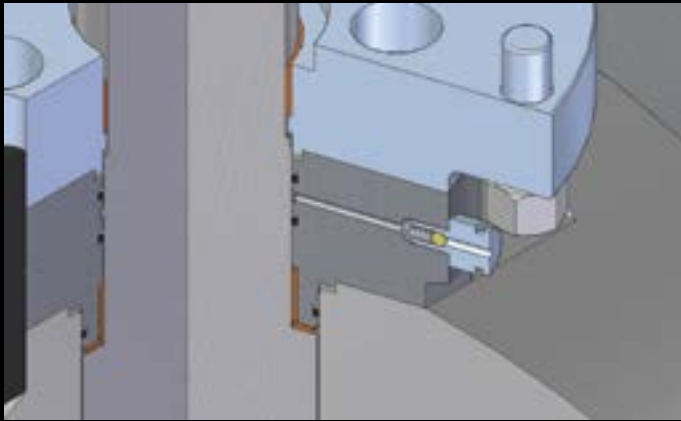

STEM SEALING SYSTEM

A triple barrier composed by two O-Rings and a graphite gasket is adopted as a standard feature for granting a perfect sealing and fire safety even after several valve operations.

The uppermost stem seal can be replaced with the valve in line after having depressurised the body cavity.

DOUBLE BLOCK AND BLEED DESIGN

Valve cavity can be bled through the vent/drain ports in either fully open or close positions for checking the seats integrity after installation.

SEAT FEATURES

Trunnion mounted ball valves are equipped with independent floating spring loaded seats in continuous contact with the ball such to grant an effective sealing even at low differential pressure or for slow pressure build-up.

Both self relieving and double piston effect seat versions are available.

The self relieving arrangement grants an automatic relief in case of possible cavity over-pressurization. In this case the pressure path around the upstream seat is such to generate a piston effect pushing the seat tightly against the ball surface.

The downstream seat, when the body cavity pressure is greater than the spring load, automatically relieves the cavity overpressure to the downstream conduit.

The double piston effect (DPE) arrangement is such to grant a thrust pushing the seats against the ball whichever is the differential pressure direction between the cavity and the conduits. In such a way, the downstream seat holds the pressure even when the upstream one fails for any reason. For this arrangement an automatic external relief device may be necessary.

A combination of a self relieving upstream seat and a downstream double piston effect one is available upon request.

This configuration provides a double barrier along the preferred flow direction granting at the same time an automatic cavity relieving.

Double Block & Bleed functionality is granted with any of the above described seat arrangement.

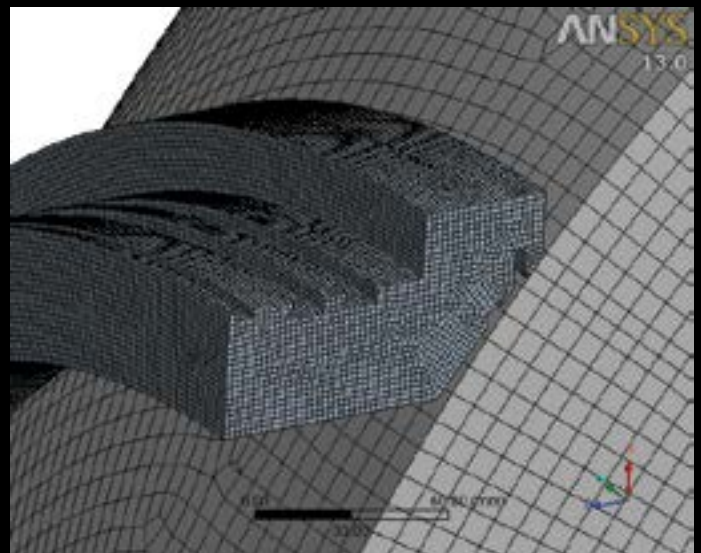

Perar - Technical Features

SOFT SEATED VALVES

Soft seated ball valves have a resilient insert firmly installed into a seat front groove for granting a perfect tightness under all conditions other than dirty or abrasive services.

METAL SEATED VALVES

PERAR trunnion mounted ball valves intended for dirty, sandy or high temperature services are designed with metal-to-metal sealing between the ball and the seat rings. These parts are hard-faced using different coatings, such as Tungsten or Chromium Carbides, depending on process type. An advanced design approach is applied using FEA technique for achieving tight shut off performances even with metal seating.

system can also be used for routine flushing of seat ring areas when needed.

STEM EXTENSION

PERAR ball valves are available with additional stem extension for underground installation. Stem extensions are made to customer requirements and can be completed upon request with vent, drain and sealant injection extended lines.

EXTENDED BONNET

Valves for low temperature / cryogenic services or for very high temperatures are equipped with extended bonnet for granting vapour space between the valve core and the stem sealing system.

This system prevents stem seals from damages at extreme temperatures and allows servicing also when valves are installed on insulated lines.

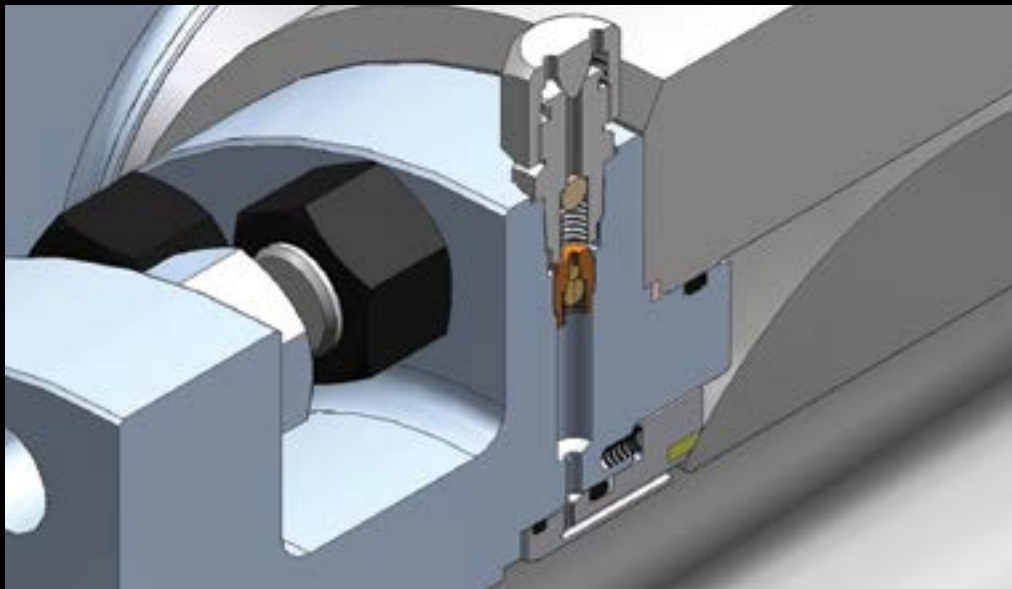

EMERGENCY SEALANT INJECTION

A sealant injection system is available upon request allowing the restoring of stem and/or seat tightness in case of damages of sealing components (either O-rings or seat inserts) and/or surfaces caused by possible presence of solid particles in the process fluid. The injection

PUPS

Valves with butt welded ends may be supplied complete with welded transition pieces and/or pups to avoid any damage of the valve non-metal internals during the welding activities on site.



Applicable Standards

API - American Petroleum Institute

API 6D	Specification for Pipeline Valves
API 6A	Specification for Wellhead and Christmas Tree Equipment
API 6FA	Specification for Fire Test for Valves

ASME - American Standard Institute

ASME B16.34	Valves Flanged, Threaded and Welding End
ASME VIII	ASME BPVC: Rules for Construction of Pressure Vessels, Division 1 and 2
ASME B16.5	Pipe Flanges and Flanged Fittings
ASME B16.47	Large Diameter Steel Flanges
ASME B16.25	Butt Welding Ends
ASME B31.3	Process Piping
ASME B31.8	Gas Transmission and Distribution Piping System

ASTM - American Society for testing materials

ASTM	01.01, 01.03, 01.05, 02.04
-------------	-----------------------------------

ISO - International Organization for Standardization

ISO 10313	Petroleum and natural gas industries - Pipeline transport. systems - Pipeline valves
ISO 10423:2009	Petroleum and natural gas industries - Drilling and production equipment - Wellhead and christmas tree equipment
ISO 15156	
NACE MR0175	Sulphide Stress Cracking Resistant Materials for Oil Field Equipment
ISO 5208	Industrial valve - Pressure testing of valves
ISO 10497	Testing of valves - Fire type-testing requirements

MSS - Manufactures Standardization Society of the Valve And Fittings Industry

MSS SP-44	Steel Pipeline Flanges
------------------	-------------------------------





Perar

Trunnion Mounted
Side Entry Bolted Body Ball Valves



THAT'S **Perar**
QUALITY

The Best Guarantee of Safety

Perar



Component Parts

Part No.	Description
01	Body
03	Seat Ring
04	Ball
05	Seat Spring
06	Stem
07	Upper Thrust Washer
08	Closure
09a	Body Gasket
09b	Closure O-Ring
10a	Gland Plate Stud
16	Stem O-Ring
16a	Stem Gasket
17a	Gland Plate Nut
24	Body Stud
25	Body Stud Nut
27a	Ball Bearing
27b	Stem Bearing
28a	Upper Thrust Washer
28b	Lower Thrust Washer
30	Gland Plate
31	Gland Plate Gasket
32	Gland Plate O-Ring
33	Seat O-Ring
33a	Sealant Seal O-Ring

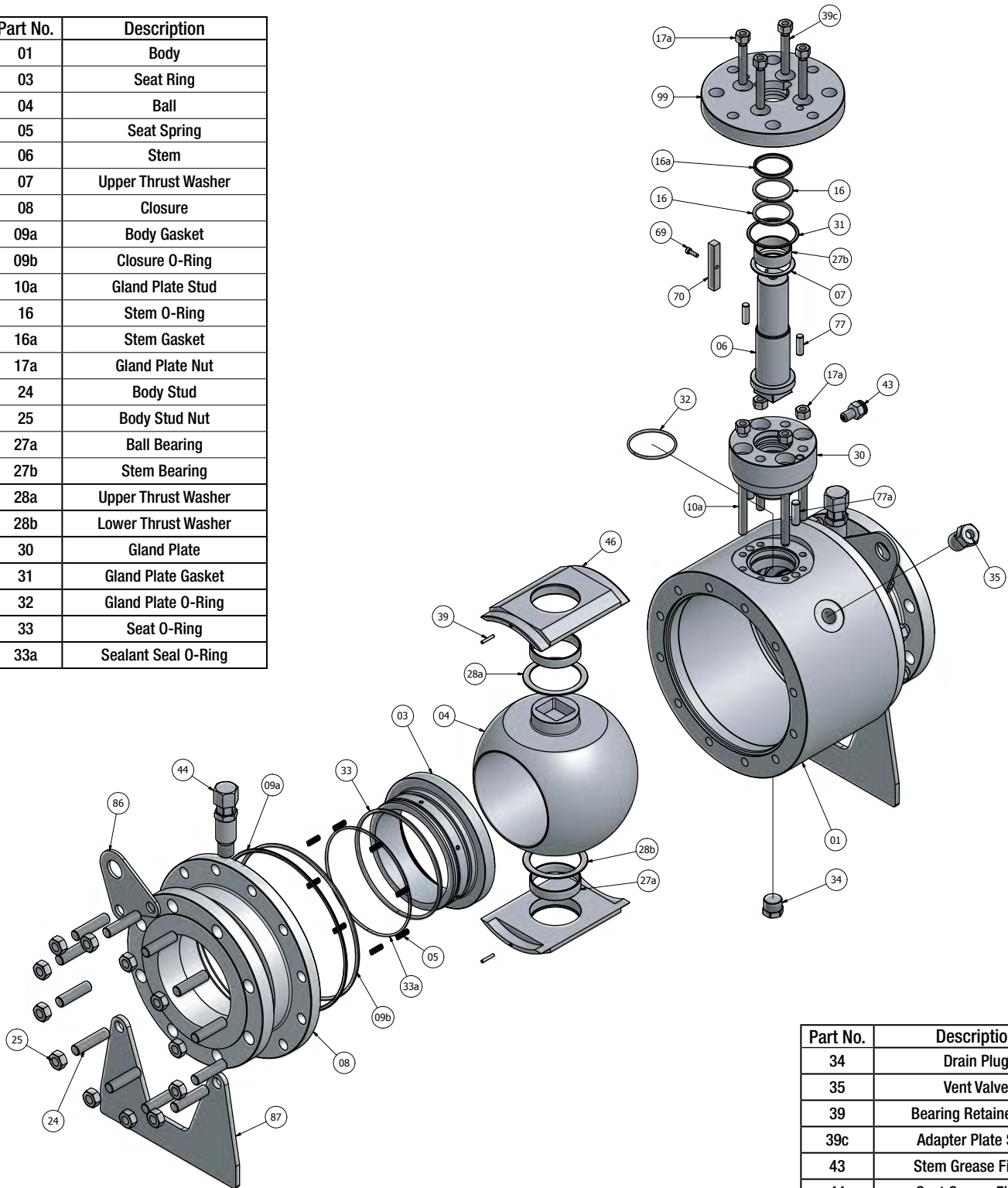

Part No.	Description
34	Drain Plug
35	Vent Valve
39	Bearing Retainer Pin
39c	Adapter Plate Stud
43	Stem Grease Fitting
44	Seat Grease Fitting
46	Bearing Retainer
69	Stem Key Screw
70	Stem Key
77	Adapter Plate Pin
77a	Gland Plate Pin
86	Lifting Lugs
87	Feet
99	Adapter Plate



Valve Material Selection

BODY, CLOSURE

CS (ASTM A105, ASTM A216), LTCS (ASTM A350 LF2, ASTM A352)
High strength LTCS (A694 F52, F60, F65)
Austenitic SS (ASTM A182 F304, F316, ASTM A351 CF3, CF3M, CF8, CF8M)
Duplex SS 22% Cr (ASTM A182 F51, ASTM A890, A995)
Superduplex SS 25% Cr (ASTM A182 F53/F55, ASTM A890, A995)
6Mo SS (ASTM A182 F44, ASTM)
Inconel 625
Incoloy 825
Monel

TRIM (SEAT, BALL AND STEM)

CS (ASTM A105), LTCS (ASTM A350 LF2) + ENP 0.003"
High strength LTCS (A694 F52, F60, F65) + ENP 0.003"
AISI 410 Martensitic SS (ASTM A182 F6a)
17-4 PH
Austenitic SS (ASTM A182 F304, F316)
Duplex SS 22% Cr (ASTM A182-F51)
Superduplex SS 25% Cr (ASTM A182 F53/F55)
6Mo SS (ASTM A182 F44)
Inconel 625
Inconel 718
Incoloy 825
Monel

BODY SEALS / SEAT SEALS

Viton A FKM O-ring
Viton GLT FKM O-ring
Viton AED FKM O-ring
HNBR O-ring
FFKM O-ring
PTFE + ELGILOY Lip-Seals
Graphite Packing / Gaskets

SEAT INSERT

Viton A/GLT/AED FKM
HNBR
PTFE / RPTFE
Nylon / DEVLON V
PCTFE / KEL-F
PEEK
METAL with either Tungsten Carbide or Chromium Carbide Coating (0.15 mm min. thk.)

BOLTING

ASTM A193 B7/B7M, ASTM A320 L7/L7M
A193/A320 B8/B8M
UNS S31803, UNS S32760, ASTM A453-GR.660



ASME Class 150# Side Entry Bolted Body

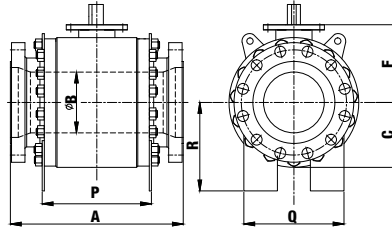

FULL BORE

FULL BORE

	SIZE	A(RF)	A(BW)	B	C	F	P	Q	R	WEIGHT
inch-lb	2	7,01	8,50	1,93	3,54	5,08	n.a.	n.a.	n.a.	73
mm-Kg	50	178	216	49	90	129	n.a.	n.a.	n.a.	33
inch-lb	3	7,99	11,14	2,91	4,21	6,06	n.a.	n.a.	n.a.	99
mm-Kg	80	203	283	74	107	154	n.a.	n.a.	n.a.	45
inch-lb	4	9,02	12,01	3,94	5,24	7,36	n.a.	n.a.	n.a.	209
mm-Kg	100	229	305	100	133	187	n.a.	n.a.	n.a.	95
inch-lb	6	15,51	17,99	5,91	6,54	9,25	9,69	11,02	10,71	337
mm-Kg	150	394	457	150	166	235	246	280	272	153
inch-lb	8	17,99	20,51	7,91	7,87	10,75	9,92	13,11	11,81	556
mm-Kg	200	457	521	201	200	273	252	333	300	252
inch-lb	10	20,98	22,01	9,92	9,57	12,48	14,84	16,77	13,50	917
mm-Kg	250	533	559	252	243	317	377	426	343	416
inch-lb	12	24,02	25,00	11,93	11,02	13,90	17,76	16,85	16,34	1371
mm-Kg	300	610	635	303	280	353	451	428	415	622
inch-lb	14	27,01	30,00	13,15	12,01	14,88	20,31	19,29	17,24	2028
mm-Kg	350	686	762	334	305	378	516	490	438	920
inch-lb	16	30,00	32,99	15,16	13,70	16,34	22,83	22,09	19,02	2557
mm-Kg	400	762	838	385	348	415	580	561	483	1160
inch-lb	18	34,02	35,98	17,17	15,35	18,31	25,75	26,42	20,67	3594
mm-Kg	450	864	914	436	390	465	654	671	525	1630
inch-lb	20	35,98	39,02	19,17	16,65	19,69	28,46	25,08	21,89	4630
mm-Kg	500	914	991	487	423	500	723	637	556	2100
inch-lb	22	*	*	*	*	*	*	*	*	*
mm-Kg	550	*	*	*	*	*	*	*	*	*

	SIZE	A(RF)	A(BW)	B	C	F	P	Q	R	WEIGHT
inch-lb	24	42,01	45,00	23,19	19,69	22,72	33,07	27,09	25,00	7275
mm-Kg	600	1067	1143	589	500	577	840	688	635	3300
inch-lb	26	45,00	49,02	24,92	21,30	24,33	34,45	35,35	26,61	8730
mm-Kg	650	1143	1245	633	541	618	875	898	676	3960
inch-lb	28	49,02	52,99	26,93	22,44	25,31	36,22	33,66	27,76	10185
mm-Kg	700	1245	1346	684	570	643	920	855	705	4620
inch-lb	30	50,98	55,00	28,94	24,02	27,64	39,13	34,41	29,33	11640
mm-Kg	750	1295	1397	735	610	702	994	874	745	5280
inch-lb	32	54,02	60,00	30,67	25,87	29,53	41,34	40,55	31,18	14881
mm-Kg	800	1372	1524	779	657	750	1050	1030	792	6750
inch-lb	34	57,99	64,02	32,68	27,17	30,28	42,56	43,15	32,48	16909
mm-Kg	850	1473	1626	830	690	769	1081	1096	825	7670
inch-lb	36	60,00	67,99	34,41	28,27	32,05	45,67	45,28	33,58	18960
mm-Kg	900	1524	1727	874	718	814	1160	1150	853	8600
inch-lb	38	*	*	*	*	*	*	*	*	*
mm-Kg	950	*	*	*	*	*	*	*	*	*
inch-lb	40	66,14	*	38,43	31,89	34,96	46,06	52,17	37,20	21164
mm-Kg	1000	1680	*	976	810	888	1170	1325	945	9600
inch-lb	42	67,99	*	40,16	33,23	36,93	52,17	51,30	38,39	30137
mm-Kg	1050	1727	*	1020	844	938	1325	1303	975	13670
inch-lb	48	72,99	*	45,91	37,99	42,80	56,02	58,74	43,31	43585
mm-Kg	1200	1854	*	1166	965	1087	1423	1492	1100	19770
*	*	*	*	*	*	*	*	*	*	*
*	*	*	*	*	*	*	*	*	*	*



"All the above dimensions and weights could be subjected to changes by Perar SpA without any notification, due to engineering activities. Therefore, please consult the factory for confirmation on the above data as well as for other dimensions and weights not reported in the table".

ASME Class 150# Side Entry Bolted Body

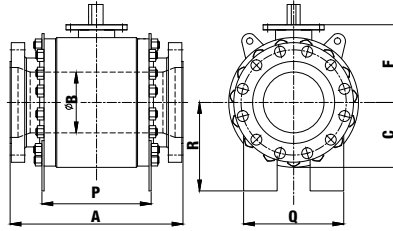

REDUCED BORE

REDUCED BORE

	SIZE	A(RF)	A(BW)	B	C	F	P	Q	R	WEIGHT
inch-lb	3x2	7,99	11,14	1,93	3,54	5,08	n.a.	n.a.	n.a.	79
mm-Kg	80x50	203	283	49	90	129	n.a.	n.a.	n.a.	36
inch-lb	4x3	9,02	12,01	2,91	4,21	6,06	n.a.	n.a.	n.a.	110
mm-Kg	100x80	229	305	74	107	154	n.a.	n.a.	n.a.	50
inch-lb	6x4	15,51	17,99	3,94	5,24	7,36	n.a.	n.a.	n.a.	229
mm-Kg	150x100	394	457	100	133	187	n.a.	n.a.	n.a.	104
inch-lb	8x6	17,99	20,51	5,91	6,54	9,25	9,69	11,02	10,71	375
mm-Kg	200x150	457	521	150	166	235	246	280	272	170
inch-lb	10x6	20,98	22,01	5,91	6,54	9,25	9,69	11,02	10,71	408
mm-Kg	250x150	533	559	150	166	235	246	280	272	185
inch-lb	10x8	20,98	22,01	7,91	7,87	10,75	9,92	13,11	11,81	595
mm-Kg	250x200	533	559	201	200	273	252	333	300	270
inch-lb	12x8	24,02	25,00	7,91	7,87	10,75	9,92	13,11	11,81	661
mm-Kg	300x200	610	635	201	200	273	252	333	300	300
inch-lb	12x10	24,02	25,00	9,92	9,57	12,48	14,84	16,77	13,50	970
mm-Kg	300x250	610	635	252	243	317	377	426	343	440
inch-lb	14x10	27,01	30,00	9,92	9,57	12,48	14,84	16,77	13,50	1019
mm-Kg	350x250	686	762	252	243	317	377	426	343	462
inch-lb	14x12	27,01	30,00	11,93	11,02	13,90	17,76	16,85	16,34	1440
mm-Kg	350x300	686	762	303	280	353	451	428	415	653
inch-lb	16x12	30,00	32,99	11,93	11,02	13,90	17,76	16,85	16,34	1521
mm-Kg	400x300	762	838	303	280	353	451	428	415	690
inch-lb	16x14	30,00	32,99	13,15	12,01	14,88	20,31	19,29	17,24	2130
mm-Kg	400x350	762	838	334	305	378	516	490	438	966
inch-lb	18x14	34,02	35,98	13,15	12,01	14,88	20,31	19,29	17,24	2756
mm-Kg	450x350	864	914	334	305	378	516	490	438	1250

	SIZE	A(RF)	A(BW)	B	C	F	P	Q	R	WEIGHT
inch-lb	18x16	34,02	35,98	15,16	13,70	16,34	22,83	22,09	19,02	2646
mm-Kg	450x400	864	914	385	348	415	580	561	483	1200
inch-lb	20x16	35,98	39,02	15,16	13,70	16,34	22,83	22,09	19,02	2822
mm-Kg	500x400	914	991	385	348	415	580	561	483	1280
inch-lb	20x18	35,98	39,02	17,17	15,35	18,31	25,75	26,42	20,67	3748
mm-Kg	500x450	914	991	436	390	465	654	671	525	1700
inch-lb	24x20	42,01	45,00	19,17	16,65	19,69	28,46	25,08	21,89	4872
mm-Kg	600x500	1067	1143	487	423	500	723	637	556	2210
inch-lb	28x24	49,02	52,99	23,19	19,69	22,72	33,07	27,09	25,00	7606
mm-Kg	700x600	1245	1346	589	500	577	840	688	635	3450
inch-lb	30x24	50,98	55,00	23,19	19,69	22,72	33,07	27,09	25,00	7937
mm-Kg	750x600	1295	1397	589	500	577	840	688	635	3600
inch-lb	28x26	49,02	52,99	24,92	21,30	24,33	34,45	35,35	26,61	8598
mm-Kg	700x650	1245	1346	633	541	618	875	898	676	3900
inch-lb	30x26	50,98	55,00	24,92	21,30	24,33	34,45	35,35	26,61	9149
mm-Kg	750x650	1295	1397	633	541	618	875	898	676	4150
inch-lb	30x28	50,98	55,00	26,93	22,44	25,31	36,22	33,66	27,76	10692
mm-Kg	750x700	1295	1397	684	570	643	920	855	705	4850
inch-lb	36x30	60,00	67,99	28,94	24,02	27,64	39,13	34,41	29,33	12346
mm-Kg	900x750	1524	1727	735	610	702	994	874	745	5600
inch-lb	36x32	60,00	67,99	30,67	25,87	29,53	41,34	40,55	31,18	15653
mm-Kg	900x800	1524	1727	779	657	750	1050	1030	792	7100
inch-lb	36x34	60,00	67,99	32,68	*	*	*	*	*	*
mm-Kg	900x850	1524	1727	830	*	*	*	*	*	*
*	*	*	*	*	*	*	*	*	*	*
*	*	*	*	*	*	*	*	*	*	*

"All the above dimensions and weights could be subjected to changes by Perar SpA without any notification, due to engineering activities. Therefore, please consult the factory for confirmation on the above data as well as for other dimensions and weights not reported in the table".



ASME Class 300# Side Entry Bolted Body

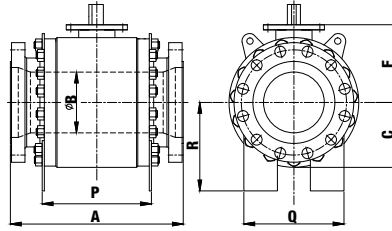

FULL BORE

FULL BORE

	SIZE	A(RF)	A(BW)	B	C	F	P	Q	R	WEIGHT
inch-lb	2	8,50	8,50	1,93	3,54	5,51	n.a.	n.a.	n.a.	62
mm-Kg	50	216	216	49	90	140	n.a.	n.a.	n.a.	28
inch-lb	3	11,14	11,14	2,91	4,33	6,30	n.a.	n.a.	n.a.	132
mm-Kg	80	283	283	74	110	160	n.a.	n.a.	n.a.	60
inch-lb	4	12,01	12,01	3,94	5,08	7,40	n.a.	n.a.	n.a.	287
mm-Kg	100	305	305	100	129	188	n.a.	n.a.	n.a.	130
inch-lb	6	15,87	17,99	5,91	6,54	9,25	10,00	11,02	10,71	441
mm-Kg	150	403	457	150	166	235	254	280	272	200
inch-lb	8	19,76	20,51	7,91	7,87	10,75	9,92	13,11	11,81	595
mm-Kg	200	502	521	201	200	273	252	333	300	270
inch-lb	10	22,36	22,01	9,92	9,76	12,52	14,84	18,11	13,70	1036
mm-Kg	250	568	559	252	248	318	377	460	348	470
inch-lb	12	25,51	25,00	11,93	11,34	13,94	17,68	18,35	16,34	1565
mm-Kg	300	648	635	303	288	354	449	466	415	710
inch-lb	14	30,00	30,00	13,15	12,40	15,16	21,02	19,49	17,72	2205
mm-Kg	350	762	762	334	315	385	534	495	450	1000
inch-lb	16	32,99	32,99	15,16	13,90	16,85	22,83	22,52	19,21	2998
mm-Kg	400	838	838	385	353	428	580	572	488	1360
inch-lb	18	35,98	35,98	17,17	15,67	18,50	26,14	20,79	20,87	4012
mm-Kg	450	914	914	436	398	470	664	528	530	1820
inch-lb	20	39,02	39,02	19,17	16,93	20,04	29,41	26,34	22,24	5137
mm-Kg	500	991	991	487	430	509	747	669	565	2330
inch-lb	22	42,99	42,99	21,18	18,62	21,77	31,26	26,18	23,94	6393
mm-Kg	550	1092	1092	538	473	553	794	665	608	2900

	SIZE	A(RF)	A(BW)	B	C	F	P	Q	R	WEIGHT
inch-lb	24	45,00	45,00	23,19	20,00	23,54	33,39	31,69	25,31	8051
mm-Kg	600	1143	1143	589	508	598	848	805	643	3652
inch-lb	26	49,02	49,02	24,92	21,46	25,00	36,06	32,60	26,77	9590
mm-Kg	650	1245	1245	633	545	635	916	828	680	4350
inch-lb	28	52,99	52,99	26,93	23,23	26,77	38,58	32,91	28,54	12059
mm-Kg	700	1346	1346	684	590	680	980	836	725	5470
inch-lb	30	55,00	55,00	28,94	24,80	28,43	40,55	37,40	30,12	14088
mm-Kg	750	1397	1397	735	630	722	1030	950	765	6390
inch-lb	32	60,00	60,00	30,67	26,97	30,63	44,49	39,37	32,28	17240
mm-Kg	800	1524	1524	779	685	778	1130	1000	820	7820
inch-lb	34	64,02	64,02	32,68	27,76	31,46	45,28	41,69	33,07	20723
mm-Kg	850	1626	1626	830	705	799	1150	1059	840	9400
inch-lb	36	67,99	67,99	34,41	29,13	32,76	48,43	44,29	35,63	23545
mm-Kg	900	1727	1727	874	740	832	1230	1125	905	10680
inch-lb	38	*	*	*	*	*	*	*	*	*
mm-Kg	950	*	*	*	*	*	*	*	*	*
inch-lb	40	67,99	*	38,43	32,44	36,14	51,57	38,98	37,76	26235
mm-Kg	1000	1727	*	976	824	918	1310	990	959	11900
inch-lb	42	72,99	*	40,16	33,94	38,66	54,92	48,35	39,17	33510
mm-Kg	1050	1854	*	1020	862	982	1395	1228	995	15200
inch-lb	48	77,64	*	45,91	38,86	44,17	56,42	56,85	44,49	47840
mm-Kg	1200	1972	*	1166	987	1122	1433	1444	1130	21700
*	*	*	*	*	*	*	*	*	*	*
*	*	*	*	*	*	*	*	*	*	*



ASME Class 300# Side Entry Bolted Body

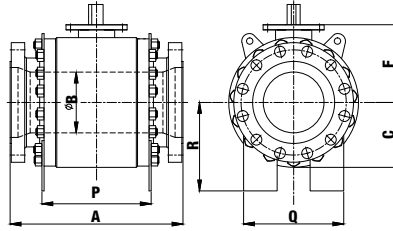

REDUCED BORE

REDUCED BORE

	SIZE	A(RF)	A(BW)	B	C	F	P	Q	R	WEIGHT
inch-lb	3x2	11,14	11,14	1,93	3,54	5,51	n.a.	n.a.	n.a.	68
mm-Kg	80x50	283	283	49	90	140	n.a.	n.a.	n.a.	31
inch-lb	4x3	12,01	12,01	2,91	4,33	6,30	n.a.	n.a.	n.a.	146
mm-Kg	100x80	305	305	74	110	160	n.a.	n.a.	n.a.	66
inch-lb	6x4	15,87	17,99	3,94	5,08	7,40	n.a.	n.a.	n.a.	315
mm-Kg	150x100	403	457	100	129	188	n.a.	n.a.	n.a.	143
inch-lb	8x6	19,76	20,51	5,91	6,54	9,25	10,00	11,02	11,81	441
mm-Kg	200x150	502	521	150	166	235	254	280	300	200
inch-lb	10x6	22,36	22,01	5,91	6,54	9,25	10,00	11,02	11,81	485
mm-Kg	250x150	568	559	150	166	235	254	280	300	220
inch-lb	10x8	22,36	22,01	7,91	7,87	10,75	9,92	13,11	11,81	655
mm-Kg	250x200	568	559	201	200	273	252	333	300	297
inch-lb	12x8	25,51	25,00	7,91	7,87	10,75	9,92	13,11	11,81	723
mm-Kg	300x200	648	635	201	200	273	252	333	300	328
inch-lb	12x10	25,51	25,00	9,92	9,76	12,52	14,84	18,11	13,70	1091
mm-Kg	300x250	648	635	252	248	318	377	460	348	495
inch-lb	14x10	30,00	30,00	9,92	9,76	12,52	14,84	18,11	13,70	1146
mm-Kg	350x250	762	762	252	248	318	377	460	348	520
inch-lb	14x12	30,00	30,00	11,93	11,34	13,94	17,68	18,35	16,34	1653
mm-Kg	350x300	762	762	303	288	354	449	466	415	750
inch-lb	16x12	32,99	32,99	11,93	11,34	13,94	17,68	18,35	16,34	1742
mm-Kg	400x300	838	838	303	288	354	449	466	415	790
inch-lb	16x14	32,99	32,99	13,15	12,40	15,16	21,02	19,49	17,72	2315
mm-Kg	400x350	838	838	334	315	385	534	495	450	1050

	SIZE	A(RF)	A(BW)	B	C	F	P	Q	R	WEIGHT
inch-lb	18x14	35,98	35,98	13,15	12,40	15,16	21,02	19,49	17,72	2866
mm-Kg	450x350	914	914	334	315	385	534	495	450	1300
inch-lb	18x16	35,98	35,98	15,16	13,90	16,85	22,83	22,52	19,21	3153
mm-Kg	450x400	914	914	385	353	428	580	572	488	1430
inch-lb	20x16	39,02	39,02	15,16	13,90	16,85	22,83	22,52	19,21	3307
mm-Kg	500x400	991	991	385	353	428	580	572	488	1500
inch-lb	20x18	39,02	39,02	17,17	15,67	18,50	26,14	20,79	20,87	4211
mm-Kg	500x450	991	991	436	398	470	664	528	530	1910
inch-lb	24x20	45,00	45,00	19,17	16,93	20,04	29,41	26,34	22,24	5401
mm-Kg	600x500	1143	1143	487	430	509	747	669	565	2450
inch-lb	28x24	52,99	52,99	23,19	20,00	23,54	33,39	31,69	25,31	8444
mm-Kg	700x600	1346	1346	589	508	598	848	805	643	3830
inch-lb	30x24	55,00	55,00	23,19	20,00	23,54	33,39	31,69	25,31	8885
mm-Kg	750x600	1397	1397	589	508	598	848	805	643	4030
inch-lb	28x26	52,99	52,99	24,92	21,46	25,00	36,06	32,60	26,77	10031
mm-Kg	700x650	1346	1346	633	545	635	916	828	680	4550
inch-lb	30x28	55,00	55,00	26,93	23,23	26,77	38,58	32,91	28,54	12655
mm-Kg	750x700	1397	1397	684	590	680	980	836	725	5740
inch-lb	36x30	67,99	67,99	28,94	24,80	28,43	40,55	37,40	30,12	14793
mm-Kg	900x750	1727	1727	735	630	722	1030	950	765	6710
inch-lb	36x32	67,99	67,99	30,67	26,97	30,63	44,49	39,37	32,28	18078
mm-Kg	900x800	1727	1727	779	685	778	1130	1000	820	8200
inch-lb	36x34	67,99	67,99	32,68	27,76	31,46	45,28	41,69	33,07	21605
mm-Kg	900x850	1727	1727	830	705	799	1150	1059	840	9800

"All the above dimensions and weights could be subjected to changes by Perar SpA without any notification, due to engineering activities. Therefore, please consult the factory for confirmation on the above data as well as for other dimensions and weights not reported in the table".



ASME Class 600# Side Entry Bolted Body

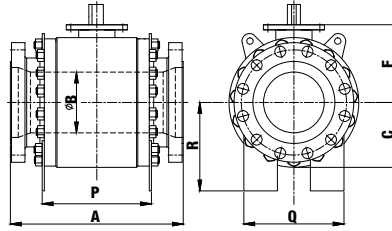

FULL BORE

FULL BORE

	SIZE	A(RF)	A(BW)	B	C	F	P	Q	R	WEIGHT
inch-lb	2	11,50	11,50	1,93	3,74	5,51	n.a.	n.a.	n.a.	75
mm-Kg	50	292	292	49	95	140	n.a.	n.a.	n.a.	34
inch-lb	3	14,02	14,02	2,91	4,45	6,30	n.a.	n.a.	n.a.	198
mm-Kg	80	356	356	74	113	160	n.a.	n.a.	n.a.	90
inch-lb	4	17,01	17,01	3,94	5,43	8,31	n.a.	n.a.	n.a.	309
mm-Kg	100	432	432	100	138	211	n.a.	n.a.	n.a.	140
inch-lb	6	22,01	22,01	5,91	6,57	10,35	12,05	10,91	10,47	595
mm-Kg	150	559	559	150	167	263	306	277	266	270
inch-lb	8	25,98	25,98	7,91	8,07	10,91	14,96	15,20	11,81	908
mm-Kg	200	660	660	201	205	277	380	386	300	412
inch-lb	10	30,98	30,98	9,92	9,84	12,52	17,28	16,10	13,39	1543
mm-Kg	250	787	787	252	250	318	439	409	340	700
inch-lb	12	32,99	32,99	11,93	11,42	14,13	19,88	15,12	16,14	2006
mm-Kg	300	838	838	303	290	359	505	384	410	910
inch-lb	14	35,00	35,00	13,15	12,72	15,43	22,44	19,92	17,44	2901
mm-Kg	350	889	889	334	323	392	570	506	443	1316
inch-lb	16	39,02	39,02	15,16	14,09	17,05	24,80	19,69	19,41	3739
mm-Kg	400	991	991	385	358	433	630	500	493	1696
inch-lb	18	42,99	42,99	17,17	15,75	18,62	28,35	23,11	21,06	5115
mm-Kg	450	1092	1092	436	400	473	720	587	535	2320
inch-lb	20	47,01	47,01	19,17	17,13	20,00	31,22	25,12	22,44	6239
mm-Kg	500	1194	1194	487	435	508	793	638	570	2830
inch-lb	22	50,98	50,98	21,18	20,08	23,62	33,86	29,45	25,39	8179
mm-Kg	550	1295	1295	538	510	600	860	748	645	3710

	SIZE	A(RF)	A(BW)	B	C	F	P	Q	R	WEIGHT
inch-lb	24	55,00	55,00	23,19	20,28	23,82	36,61	29,65	25,59	10119
mm-Kg	600	1397	1397	589	515	605	930	753	650	4590
inch-lb	26	57,01	57,01	24,92	22,24	25,79	40,00	34,96	27,56	12809
mm-Kg	650	1448	1448	633	565	655	1016	888	700	5810
inch-lb	28	60,98	60,98	26,93	25,00	28,54	41,34	39,09	30,31	15543
mm-Kg	700	1549	1549	684	635	725	1050	993	770	7050
inch-lb	30	65,00	65,00	28,94	25,16	29,76	42,52	40,75	30,47	18188
mm-Kg	750	1651	1651	735	639	756	1080	1035	774	8250
inch-lb	32	70,00	70,00	30,67	27,20	32,09	46,85	47,05	32,56	21870
mm-Kg	800	1778	1778	779	691	815	1190	1195	827	9920
inch-lb	34	75,98	75,98	32,68	28,27	32,87	48,43	43,19	33,58	25353
mm-Kg	850	1930	1930	830	718	835	1230	1097	853	11500
inch-lb	36	82,01	82,01	34,41	29,92	34,65	51,57	42,60	35,04	29255
mm-Kg	900	2083	2083	874	760	880	1310	1082	890	13270
inch-lb	38	*	*	*	*	*	*	*	*	*
mm-Kg	950	*	*	*	*	*	*	*	*	*
inch-lb	40	80,00	*	38,43	33,66	38,43	55,91	43,43	38,98	38581
mm-Kg	1000	2032	*	976	855	976	1420	1103	990	17500
inch-lb	42	82,01	*	40,16	34,88	40,20	58,46	57,17	40,16	43211
mm-Kg	1050	2083	*	1020	886	1021	1485	1452	1020	19600
inch-lb	48	86,61	*	45,91	39,37	44,76	50,12	58,66	44,61	52228
mm-Kg	1200	2200	*	1166	1000	1137	1273	1490	1133	23690
*	*	*	*	*	*	*	*	*	*	*
*	*	*	*	*	*	*	*	*	*	*



ASME Class 600# Side Entry Bolted Body

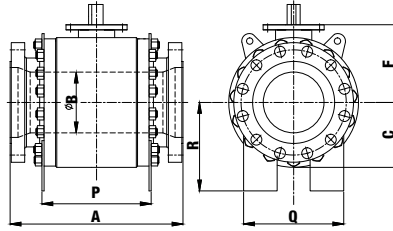

REDUCED BORE

REDUCED BORE

	SIZE	A(RF)	A(BW)	B	C	F	P	Q	R	WEIGHT
inch-lb	3x2	14,02	14,02	1,93	3,74	5,51	n.a.	n.a.	n.a.	84
mm-Kg	80x50	356	356	49	95	140	n.a.	n.a.	n.a.	38
inch-lb	4x3	17,01	17,01	2,91	4,45	6,30	n.a.	n.a.	n.a.	220
mm-Kg	100x80	432	432	74	113	160	n.a.	n.a.	n.a.	100
inch-lb	6x4	22,01	22,01	3,94	5,43	8,31	n.a.	n.a.	n.a.	342
mm-Kg	150x100	559	559	100	138	211	n.a.	n.a.	n.a.	155
inch-lb	8x6	25,98	25,98	5,91	6,57	10,35	12,05	10,91	10,47	661
mm-Kg	200x150	660	660	150	167	263	306	277	266	300
inch-lb	10x6	30,98	30,98	5,91	6,57	10,35	12,05	10,91	10,47	728
mm-Kg	250x150	787	787	150	167	263	306	277	266	330
inch-lb	10x8	30,98	30,98	7,91	8,07	10,91	14,96	15,20	11,81	992
mm-Kg	250x200	787	787	201	205	277	380	386	300	450
inch-lb	12x8	32,99	32,99	7,91	8,07	10,91	14,96	15,20	11,81	1091
mm-Kg	300x200	838	838	201	205	277	380	386	300	495
inch-lb	12x10	32,99	32,99	9,92	9,84	12,52	17,28	16,10	13,39	1698
mm-Kg	300x250	838	838	252	250	318	439	409	340	770
inch-lb	14x10	35,00	35,00	9,92	9,84	12,52	17,28	16,10	13,39	1867
mm-Kg	350x250	889	889	252	250	318	439	409	340	847
inch-lb	14x12	35,00	35,00	11,93	11,42	14,13	19,88	15,12	16,14	2205
mm-Kg	350x300	889	889	303	290	359	505	384	410	1000
inch-lb	16x12	39,02	39,02	11,93	11,42	14,13	19,88	15,12	16,14	2315
mm-Kg	400x300	991	991	303	290	359	505	384	410	1050
inch-lb	16x14	39,02	39,02	13,15	12,72	15,43	22,44	19,92	17,44	3042
mm-Kg	400x350	991	991	334	323	392	570	506	443	1380
inch-lb	18x14	42,99	42,99	13,15	12,72	15,43	22,44	19,92	17,44	3638
mm-Kg	450x350	1092	1092	334	323	392	570	506	443	1650

	SIZE	A(RF)	A(BW)	B	C	F	P	Q	R	WEIGHT
inch-lb	18x16	42,99	42,99	15,16	14,09	17,05	24,80	19,69	19,41	3924
mm-Kg	450x400	1092	1092	385	358	433	630	500	493	1780
inch-lb	20x16	47,01	47,01	15,16	14,09	17,05	24,80	19,69	19,41	4079
mm-Kg	500x400	1194	1194	385	358	433	630	500	493	1850
inch-lb	20x18	47,01	47,01	17,17	15,75	18,62	28,35	23,11	21,06	5401
mm-Kg	500x450	1194	1194	436	400	473	720	587	535	2450
inch-lb	24x20	55,00	55,00	19,17	17,13	20,00	31,22	25,12	22,44	6548
mm-Kg	600x500	1397	1397	487	435	508	793	638	570	2970
inch-lb	28x24	60,98	60,98	23,19	20,28	23,82	36,61	29,65	25,59	10626
mm-Kg	700x600	1549	1549	589	515	605	930	753	650	4820
inch-lb	30x24	65,00	65,00	23,19	20,28	23,82	36,61	29,65	25,59	11155
mm-Kg	750x600	1651	1651	589	515	605	930	753	650	5060
inch-lb	28x26	60,98	60,98	24,92	22,24	25,79	40,00	34,96	27,56	12566
mm-Kg	700x650	1549	1549	633	565	655	1016	888	700	5700
inch-lb	30x26	65,00	65,00	24,92	22,24	25,79	40,00	34,96	27,56	13448
mm-Kg	750x650	1651	1651	633	565	655	1016	888	700	6100
inch-lb	30x28	65,00	65,00	26,93	25,00	28,54	41,34	39,09	30,31	16314
mm-Kg	750x700	1651	1651	684	635	725	1050	993	770	7400
inch-lb	36x30	82,01	82,01	28,94	25,16	29,76	42,52	40,75	30,47	19092
mm-Kg	900x750	2083	2083	735	639	756	1080	1035	774	8660
inch-lb	36x32	82,01	82,01	30,67	27,20	32,09	46,85	47,05	32,56	22928
mm-Kg	900x800	2083	2083	779	691	815	1190	1195	827	10400
inch-lb	36x34	82,01	82,01	32,68	28,27	32,87	48,43	43,19	33,58	26235
mm-Kg	900x850	2083	2083	830	718	835	1230	1097	853	11900
*	*	*	*	*	*	*	*	*	*	*
*	*	*	*	*	*	*	*	*	*	*

"All the above dimensions and weights could be subjected to changes by Perar SpA without any notification, due to engineering activities. Therefore, please consult the factory for confirmation on the above data as well as for other dimensions and weights not reported in the table".



ASME Class 1500# Side Entry Bolted Body

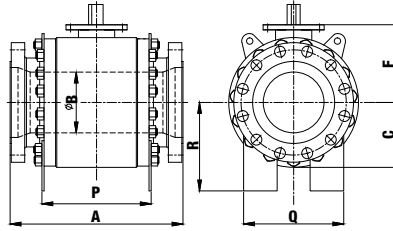

FULL BORE

REDUCED BORE

	SIZE	A(RF)	A(BW)	B	C	F	P	Q	R	WEIGHT
inch-lb	2	14,61	14,49	1,93	3,94	5,51	n.a.	n.a.	n.a.	128
mm-Kg	50	371	368	49	100	140	n.a.	n.a.	n.a.	58
inch-lb	3	18,62	18,50	2,91	4,45	6,46	n.a.	n.a.	n.a.	300
mm-Kg	80	473	470	74	113	164	n.a.	n.a.	n.a.	136
inch-lb	4	21,61	21,50	3,94	5,79	8,46	n.a.	n.a.	n.a.	661
mm-Kg	100	549	546	100	147	215	n.a.	n.a.	n.a.	300
inch-lb	6	27,99	27,76	5,67	8,07	10,87	14,02	12,99	12,01	1093
mm-Kg	150	711	705	144	205	276	356	330	305	496
inch-lb	8	33,11	32,76	7,56	9,76	12,48	17,83	16,77	13,70	1863
mm-Kg	200	841	832	192	248	317	453	426	348	845
inch-lb	10	39,37	39,02	9,41	11,81	14,61	21,06	20,24	15,75	3179
mm-Kg	250	1000	991	239	300	371	535	514	400	1442
inch-lb	12	45,12	44,49	11,30	13,70	16,54	23,23	24,57	19,02	4797
mm-Kg	300	1146	1130	287	348	420	590	624	483	2176
inch-lb	14	50,24	49,49	12,40	14,72	17,56	26,77	23,70	20,00	6724
mm-Kg	350	1276	1257	315	374	446	680	602	508	3050
inch-lb	16	55,39	54,49	14,17	16,61	19,69	30,71	28,54	21,73	8951
mm-Kg	400	1407	1384	360	422	500	780	725	552	4060
inch-lb	18	61,38	*	15,98	18,03	22,36	32,28	30,75	23,35	11045
mm-Kg	450	1559	*	406	458	568	820	781	593	5010
inch-lb	20	66,38	*	17,87	20,98	25,16	36,38	34,92	26,46	15873
mm-Kg	500	1686	*	454	533	639	924	887	672	7200
inch-lb	22	*	*	*	*	*	*	*	*	*
mm-Kg	550	*	*	*	*	*	*	*	*	*
inch-lb	24	77,64	*	21,50	24,72	29,33	42,36	41,10	30,00	29542
mm-Kg	600	1972	*	546	628	745	1076	1044	762	13400
*	*	*	*	*	*	*	*	*	*	*
*	*	*	*	*	*	*	*	*	*	*

	SIZE	A(RF)	A(BW)	B	C	F	P	Q	R	WEIGHT
inch-lb	3x2	18,62	18,50	1,93	3,94	5,51	n.a.	n.a.	n.a.	139
mm-Kg	80x50	473	470	49	100	140	n.a.	n.a.	n.a.	63
inch-lb	4x3	21,61	21,50	2,91	4,45	6,46	n.a.	n.a.	n.a.	315
mm-Kg	100x80	549	546	74	113	164	n.a.	n.a.	n.a.	143
inch-lb	6x4	27,99	27,76	3,94	5,79	8,46	n.a.	n.a.	n.a.	694
mm-Kg	150x100	711	705	100	147	215	n.a.	n.a.	n.a.	315
inch-lb	8x6	33,11	32,76	5,67	8,07	10,87	14,02	12,99	12,01	1146
mm-Kg	200x150	841	832	144	205	276	356	330	305	520
inch-lb	10x6	39,37	39,02	5,67	8,07	10,87	14,02	12,99	12,01	1257
mm-Kg	250x150	1000	991	144	205	276	356	330	305	570
inch-lb	10x8	39,37	39,02	7,56	9,76	12,48	17,83	16,77	13,70	1863
mm-Kg	250x200	1000	991	192	248	317	453	426	348	845
inch-lb	12x10	45,12	44,49	9,41	11,81	14,61	21,06	20,24	15,75	3483
mm-Kg	300x250	1146	1130	239	300	371	535	514	400	1580
inch-lb	16x12	55,39	54,49	11,30	13,70	16,54	23,23	24,57	19,02	5291
mm-Kg	400x300	1407	1384	287	348	420	590	624	483	2400
inch-lb	16x14	55,39	54,49	12,40	14,72	17,56	26,77	23,70	20,00	7275
mm-Kg	400x350	1407	1384	315	374	446	680	602	508	3300
inch-lb	18x14	61,38	*	12,40	14,72	17,56	26,77	23,70	20,00	9590
mm-Kg	450x350	1559	*	315	374	446	680	602	508	4350
inch-lb	18x16	61,38	*	14,17	16,61	19,69	30,71	28,54	21,73	9392
mm-Kg	450x400	1559	*	360	422	500	780	725	552	4260
inch-lb	20x16	66,38	*	14,17	16,61	19,69	30,71	28,54	21,73	9877
mm-Kg	500x400	1686	*	360	422	500	780	725	552	4480
inch-lb	20x18	66,38	*	15,98	18,03	22,36	32,28	30,75	23,35	11596
mm-Kg	500x450	1686	*	406	458	568	820	781	593	5260
inch-lb	24x20	77,64	*	17,87	20,98	25,16	36,38	34,92	26,46	16667
mm-Kg	600x500	1972	*	454	533	639	924	887	672	7560

"All the above dimensions and weights could be subjected to changes by Perar SpA without any notification, due to engineering activities. Therefore, please consult the factory for confirmation on the above data as well as for other dimensions and weights not reported in the table".



ASME Class 2500# Side Entry Bolted Body

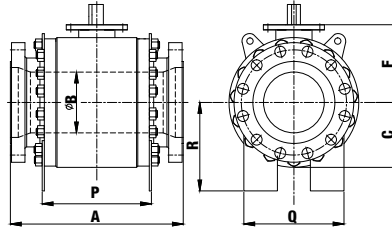

FULL BORE

REDUCED BORE

	SIZE	A(RF)	A(BW)	B	C	F	P	Q	R	WEIGHT
inch-lb	2	17,87	17,76	1,65	4,25	6,06	n.a.	n.a.	n.a.	194
mm-Kg	50	454	451	42	108	154	n.a.	n.a.	n.a.	88
inch-lb	3	22,99	22,76	2,44	6,18	8,15	n.a.	n.a.	n.a.	397
mm-Kg	80	584	578	62	157	207	n.a.	n.a.	n.a.	180
inch-lb	4	26,89	26,50	3,43	7,32	9,61	n.a.	n.a.	n.a.	661
mm-Kg	100	683	673	87	186	244	n.a.	n.a.	n.a.	300
inch-lb	6	36,50	35,98	5,16	10,04	13,23	17,72	14,96	13,90	1962
mm-Kg	150	927	914	131	255	336	450	380	353	890
inch-lb	8	40,87	40,24	7,05	12,01	15,94	20,00	20,47	15,94	4387
mm-Kg	200	1038	1022	179	305	405	508	520	405	1990
inch-lb	10	50,87	50,00	8,78	13,86	18,39	25,79	23,31	17,80	6041
mm-Kg	250	1292	1270	223	352	467	655	592	452	2740
inch-lb	12	56,89	55,98	10,43	15,35	19,92	27,99	26,38	20,67	8532
mm-Kg	300	1445	1422	265	390	506	711	670	525	3870
*	*	*	*	*	*	*	*	*	*	*
*	*	*	*	*	*	*	*	*	*	*

	SIZE	A(RF)	A(BW)	B	C	F	P	Q	R	WEIGHT
inch-lb	3x2	22,99	22,76	1,65	4,25	6,06	n.a.	n.a.	n.a.	212
mm-Kg	80x50	584	578	42	108	154	n.a.	n.a.	n.a.	96
inch-lb	4x3	26,89	26,50	2,44	6,18	8,15	n.a.	n.a.	n.a.	441
mm-Kg	100x80	683	673	62	157	207	n.a.	n.a.	n.a.	200
inch-lb	6x4	36,50	35,98	3,43	7,32	9,61	n.a.	n.a.	n.a.	728
mm-Kg	150x100	927	914	87	186	244	n.a.	n.a.	n.a.	330
inch-lb	8x6	40,87	40,24	5,16	10,04	13,23	17,72	14,96	13,90	2161
mm-Kg	200x150	1038	1022	131	255	336	450	380	353	980
inch-lb	10x6	50,87	50,00	5,16	10,04	13,23	17,72	14,96	13,90	2271
mm-Kg	250x150	1292	1270	131	255	336	450	380	353	1030
inch-lb	10x8	50,87	50,00	7,05	12,01	15,94	20,00	20,47	15,94	4828
mm-Kg	250x200	1292	1270	179	305	405	508	520	405	2190
inch-lb	12x8	56,89	55,98	7,05	12,01	15,94	20,00	20,47	15,94	5115
mm-Kg	300x200	1445	1422	179	305	405	508	520	405	2320
inch-lb	12x10	56,89	55,98	8,78	13,86	18,39	25,79	23,31	17,80	6614
mm-Kg	300x250	1445	1422	223	352	467	655	592	452	3000







Perar

Trunnion Mounted
Side Entry Welded Body Ball Valves



Perar
THAT'S
QUALITY

The Best Guarantee of Safety

Perar



Component Parts

Part No.	Description
01	Body
03	Seat Ring
04	Ball
05	Seat Spring
06	Stem
07	Upper Thrust Washer
08	Closure
10a	Gland Plate Stud
16	Stem O-Ring
16a	Stem Gasket
17a	Gland Plate Nut
27a	Ball Bearing
27b	Stem Bearing
28a	Upper Thrust Washer
28b	Lower Thrust Washer
30	Gland Plate
31	Gland Plate Gasket
32	Gland Plate O-Ring
33	Seat O-Ring
33a	Sealant Seal O-Ring
34	Drain Plug
35	Vent Valve
39	Bearing Retainer Pin
39c	Adapter Plate Stud

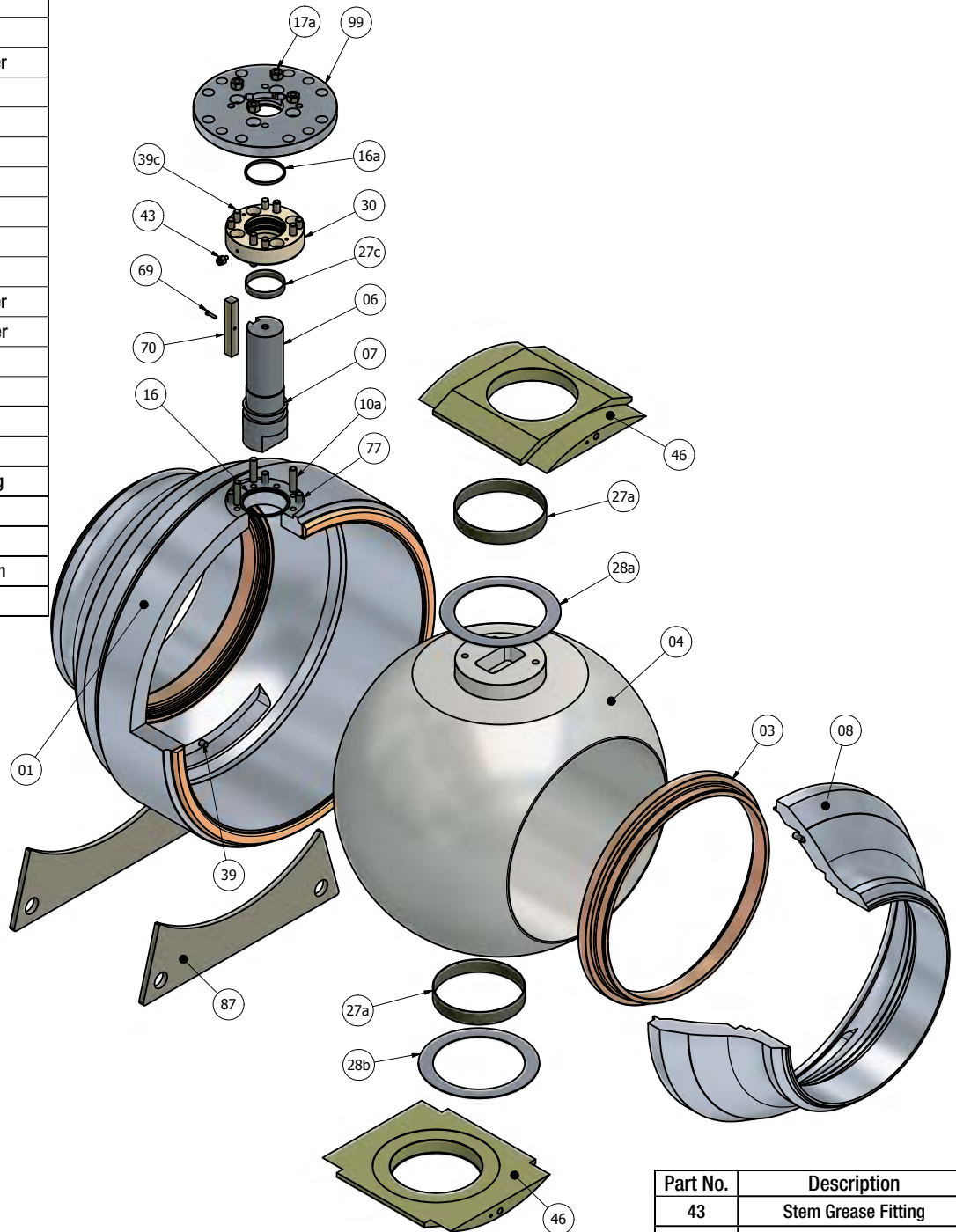

Part No.	Description
43	Stem Grease Fitting
44	Seat Grease Fitting
46	Bearing Retainer
69	Stem Key Screw
70	Stem Key
77	Adapter Plate Pin
77a	Gland Plate Pin
87	Feet
99	Adapter Plate



Valve Material Selection

BODY, CLOSURE

CS (ASTM A105, ASTM A216), LTCS (ASTM A350 LF2, ASTM A352)
High strength LTCS (A694 F52, F60, F65)
Austenitic SS (ASTM A182 F304, F316, ASTM A351 CF3, CF3M, CF8, CF8M)
Duplex SS 22% Cr (ASTM A182 F51, ASTM A890, A995)
Superduplex SS 25% Cr (ASTM A182 F53/F55, ASTM A890, A995)
6Mo SS (ASTM A182 F44, ASTM)
Inconel 625
Incoloy 825
Monel

TRIM (SEAT, BALL AND STEM)

CS (ASTM A105), LTCS (ASTM A350 LF2) + ENP 0.003"
High strength LTCS (A694 F52, F60, F65) + ENP 0.003"
AISI 410 Martensitic SS (ASTM A182 F6a)
17-4 PH
Austenitic SS (ASTM A182 F304, F316)
Duplex SS 22% Cr (ASTM A182-F51)
Superduplex SS 25% Cr (ASTM A182 F53/F55)
6Mo SS (ASTM A182 F44)
Inconel 625
Inconel 718
Incoloy 825
Monel

BODY SEALS / SEAT SEALS

Viton A FKM O-ring
Viton GLT FKM O-ring
Viton AED FKM O-ring
HNBR O-ring
FFKM O-ring
PTFE + ELGILOY Lip-Seals
Graphite Packing / Gaskets

SEAT INSERT

Viton A/GLT/AED FKM
HNBR
PTFE / RPTFE
Nylon / DEVLON V
PCTFE / KEL-F
PEEK
METAL with either Tungsten Carbide or Chromium Carbide Coating (0.15 mm min. thk.)

BOLTING

ASTM A193 B7/B7M, ASTM A320 L7/L7M
A193/A320 B8/B8M
UNS S31803, UNS S32760, ASTM A453-GR.660



ASME Class 150# Side Entry Welded Body

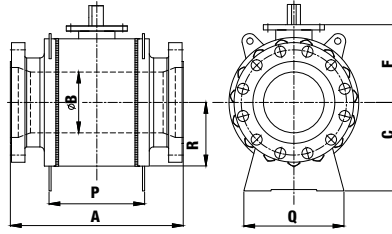

FULL BORE

FULL BORE

	SIZE	A(RF)	A(BW)	B	C	F	P	Q	R	WEIGHT
inch-lb	2	7,01	*	1,93	3,66	5,55	n.a.	n.a.	n.a.	*
mm-Kg	50	178	*	49	93	141	n.a.	n.a.	n.a.	*
inch-lb	3	7,99	*	2,91	4,25	6,22	n.a.	n.a.	n.a.	*
mm-Kg	80	203	*	74	108	158	n.a.	n.a.	n.a.	*
inch-lb	4	9,02	*	3,94	4,92	7,20	n.a.	n.a.	n.a.	*
mm-Kg	100	229	*	100	125	183	n.a.	n.a.	n.a.	*
inch-lb	6	15,51	*	5,91	6,50	9,25	10,55	9,84	10,28	*
mm-Kg	150	394	*	150	165	235	268	250	261	*
inch-lb	8	17,99	*	7,91	7,64	10,63	13,66	12,28	11,57	*
mm-Kg	200	457	*	201	194	270	347	312	294	*
inch-lb	10	20,98	*	9,92	9,21	12,05	14,96	13,66	13,82	*
mm-Kg	250	533	*	252	234	306	380	347	351	*
inch-lb	12	24,02	*	11,93	10,75	13,74	15,75	14,45	15,28	*
mm-Kg	300	610	*	303	273	349	400	367	388	*
inch-lb	14	27,01	*	13,15	12,01	15,00	11,38	20,47	15,94	*
mm-Kg	350	686	*	334	305	381	289	520	405	*
inch-lb	16	30,00	*	15,16	13,19	16,18	19,29	21,54	17,87	*
mm-Kg	400	762	*	385	335	411	490	547	454	*
inch-lb	18	*	*	*	*	*	*	*	*	*
mm-Kg	450	*	*	*	*	*	*	*	*	*
inch-lb	20	35,98	*	19,17	16,46	19,57	24,41	24,53	21,77	*
mm-Kg	500	914	*	487	418	497	620	623	553	*
inch-lb	22	*	*	*	*	*	*	*	*	*
mm-Kg	550	*	*	*	*	*	*	*	*	*

	SIZE	A(RF)	A(BW)	B	C	F	P	Q	R	WEIGHT
inch-lb	24	42,01	*	23,19	19,49	22,72	30,43	27,56	24,41	*
mm-Kg	600	1067	*	589	495	577	773	700	620	*
inch-lb	26	*	*	*	*	*	*	*	*	*
mm-Kg	650	*	*	*	*	*	*	*	*	*
inch-lb	28	*	*	*	*	*	*	*	*	*
mm-Kg	700	*	*	*	*	*	*	*	*	*
inch-lb	30	50,98	*	28,94	23,74	27,32	35,63	35,43	31,50	*
mm-Kg	750	1295	*	735	603	694	905	900	800	*
inch-lb	32	*	*	*	*	*	*	*	*	*
mm-Kg	800	*	*	*	*	*	*	*	*	*
inch-lb	34	*	*	*	*	*	*	*	*	*
mm-Kg	850	*	*	*	*	*	*	*	*	*
inch-lb	36	*	*	*	*	*	*	*	*	*
mm-Kg	900	*	*	*	*	*	*	*	*	*
inch-lb	38	*	*	*	*	*	*	*	*	*
mm-Kg	950	*	*	*	*	*	*	*	*	*
inch-lb	40	*	*	*	*	*	*	*	*	*
mm-Kg	1000	*	*	*	*	*	*	*	*	*
inch-lb	42	*	*	*	*	*	*	*	*	*
mm-Kg	1050	*	*	*	*	*	*	*	*	*
inch-lb	48	*	*	*	*	*	*	*	*	*
mm-Kg	1200	*	*	*	*	*	*	*	*	*
*	*	*	*	*	*	*	*	*	*	*
*	*	*	*	*	*	*	*	*	*	*



"All the above dimensions and weights could be subjected to changes by Perar SpA without any notification, due to engineering activities. Therefore, please consult the factory for confirmation on the above data as well as for other dimensions and weights not reported in the table".

ASME Class 150# Side Entry Welded Body

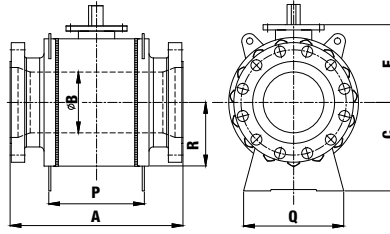

REDUCED BORE

REDUCED BORE

	SIZE	A(RF)	A(BW)	B	C	F	P	Q	R	WEIGHT
inch-lb	3x2	7,99	*	1,93	3,66	5,55	n.a.	n.a.	n.a.	*
mm-Kg	80x50	203	*	49	93	141	n.a.	n.a.	n.a.	*
inch-lb	4x3	9,02	*	2,91	4,25	6,22	n.a.	n.a.	n.a.	*
mm-Kg	100x80	229	*	74	108	158	n.a.	n.a.	n.a.	*
inch-lb	6x4	15,51	*	3,94	4,92	7,20	n.a.	n.a.	n.a.	*
mm-Kg	150x100	394	*	100	125	183	n.a.	n.a.	n.a.	*
inch-lb	8x6	17,99	*	5,91	6,50	9,25	10,55	9,84	10,28	*
mm-Kg	200x150	457	*	150	165	235	268	250	261	*
inch-lb	10x6	20,98	*	5,91	6,50	9,25	10,55	9,84	10,28	*
mm-Kg	250x150	533	*	150	165	235	268	250	261	*
inch-lb	10x8	20,98	*	7,91	7,64	10,63	13,66	12,28	11,57	*
mm-Kg	250x200	533	*	201	194	270	347	312	294	*
inch-lb	12x8	24,02	*	7,91	7,64	10,63	13,66	12,28	11,57	*
mm-Kg	300x200	610	*	201	194	270	347	312	294	*
inch-lb	12x10	24,02	*	9,92	9,21	12,05	14,96	13,66	13,82	*
mm-Kg	300x250	610	*	252	234	306	380	347	351	*
inch-lb	14x10	24,02	*	9,92	9,21	12,05	14,96	13,66	13,82	*
mm-Kg	350x250	610	*	252	234	306	380	347	351	*
inch-lb	14x12	27,01	*	11,93	10,75	13,74	15,75	14,45	15,28	*
mm-Kg	350x300	686	*	303	273	349	400	367	388	*
inch-lb	16x12	30,00	*	11,93	10,75	13,74	15,75	14,45	15,28	*
mm-Kg	400x300	762	*	303	273	349	400	367	388	*
inch-lb	16x14	30,00	*	13,15	12,01	15,00	11,38	20,47	15,94	*
mm-Kg	400x350	762	*	334	305	381	289	520	405	*
inch-lb	18x14	34,02	*	13,15	12,01	15,00	11,38	20,47	15,94	*
mm-Kg	450x350	864	*	334	305	381	289	520	405	*

	SIZE	A(RF)	A(BW)	B	C	F	P	Q	R	WEIGHT
inch-lb	18x16	34,02	*	15,16	13,19	16,18	19,29	21,54	17,87	*
mm-Kg	450x400	864	*	385	335	411	490	547	454	*
inch-lb	20x16	35,98	*	15,16	13,19	16,18	19,29	21,54	17,87	*
mm-Kg	500x400	914	*	385	335	411	490	547	454	*
inch-lb	20x18	*	*	*	*	*	*	*	*	*
mm-Kg	500x450	*	*	*	*	*	*	*	*	*
inch-lb	24x20	42,01	*	19,17	16,46	19,57	24,41	24,53	21,77	*
mm-Kg	600x500	1067	*	487	418	497	620	623	553	*
inch-lb	28x24	49,02	*	23,19	19,49	22,72	30,43	27,56	24,41	*
mm-Kg	700x600	1245	*	589	495	577	773	700	620	*
inch-lb	30x24	50,98	*	23,19	19,49	22,72	30,43	27,56	24,41	*
mm-Kg	750x600	1295	*	589	495	577	773	700	620	*
inch-lb	28x26	*	*	*	*	*	*	*	*	*
mm-Kg	700x650	*	*	*	*	*	*	*	*	*
inch-lb	30x26	*	*	*	*	*	*	*	*	*
mm-Kg	750x650	*	*	*	*	*	*	*	*	*
inch-lb	30x28	*	*	*	*	*	*	*	*	*
mm-Kg	750x700	*	*	*	*	*	*	*	*	*
inch-lb	36x30	60,00	*	28,94	23,74	27,32	35,63	35,43	31,50	*
mm-Kg	900x750	1524	*	735	603	694	905	900	800	*
inch-lb	36x32	*	*	*	*	*	*	*	*	*
mm-Kg	900x800	*	*	*	*	*	*	*	*	*
inch-lb	36x34	*	*	*	*	*	*	*	*	*
mm-Kg	900x850	*	*	*	*	*	*	*	*	*

"All the above dimensions and weights could be subjected to changes by Perar SpA without any notification, due to engineering activities. Therefore, please consult the factory for confirmation on the above data as well as for other dimensions and weights not reported in the table".



ASME Class 300# Side Entry Welded Body

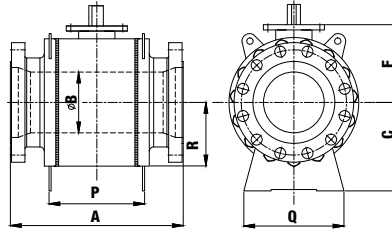

FULL BORE

FULL BORE

	SIZE	A(RF)	A(BW)	B	C	F	P	Q	R	WEIGHT
inch-lb	2	8,50	*	1,93	3,66	5,59	n.a.	n.a.	n.a.	*
mm-Kg	50	216	*	49	93	142	n.a.	n.a.	n.a.	*
inch-lb	3	11,14	*	2,91	4,33	6,61	n.a.	n.a.	n.a.	*
mm-Kg	80	283	*	74	110	168	n.a.	n.a.	n.a.	*
inch-lb	4	12,01	*	3,94	4,92	7,01	n.a.	n.a.	n.a.	*
mm-Kg	100	305	*	100	125	178	n.a.	n.a.	n.a.	*
inch-lb	6	15,87	*	5,91	6,50	9,25	10,24	10,08	9,29	*
mm-Kg	150	403	*	150	165	235	260	256	236	*
inch-lb	8	19,76	*	7,91	7,64	10,63	13,58	12,60	11,57	*
mm-Kg	200	502	*	201	194	270	345	320	294	*
inch-lb	10	22,36	*	9,92	8,78	11,22	14,02	13,62	12,48	*
mm-Kg	250	568	*	252	223	285	356	346	317	*
inch-lb	12	25,51	*	11,93	10,91	13,86	16,14	17,72	15,00	*
mm-Kg	300	648	*	303	277	352	410	450	381	*
inch-lb	14	30,00	*	13,15	12,01	14,88	17,95	19,69	16,14	*
mm-Kg	350	762	*	334	305	378	456	500	410	*
inch-lb	16	32,99	*	15,16	13,70	16,69	20,98	22,05	19,29	*
mm-Kg	400	838	*	385	348	424	533	560	490	*
inch-lb	18	35,98	*	17,17	14,96	18,03	23,70	24,65	20,16	*
mm-Kg	450	914	*	436	380	458	602	626	512	*
inch-lb	20	39,02	*	19,17	16,73	19,88	26,06	24,53	24,41	*
mm-Kg	500	991	*	487	425	505	662	623	620	*
inch-lb	22	*	*	*	*	*	*	*	*	*
mm-Kg	550	*	*	*	*	*	*	*	*	*

	SIZE	A(RF)	A(BW)	B	C	F	P	Q	R	WEIGHT
inch-lb	24	45,00	*	23,19	19,80	23,43	31,02	27,13	25,12	*
mm-Kg	600	1143	*	589	503	595	788	689	638	*
inch-lb	26	*	*	*	*	*	*	*	*	*
mm-Kg	650	*	*	*	*	*	*	*	*	*
inch-lb	28	52,99	*	26,93	22,64	26,30	34,49	31,50	27,95	*
mm-Kg	700	1346	*	684	575	668	876	800	710	*
inch-lb	30	*	*	*	*	*	*	*	*	*
mm-Kg	750	*	*	*	*	*	*	*	*	*
inch-lb	32	*	*	*	*	*	*	*	*	*
mm-Kg	800	*	*	*	*	*	*	*	*	*
inch-lb	34	*	*	*	*	*	*	*	*	*
mm-Kg	850	*	*	*	*	*	*	*	*	*
inch-lb	36	*	*	*	*	*	*	*	*	*
mm-Kg	900	*	*	*	*	*	*	*	*	*
inch-lb	38	*	*	*	*	*	*	*	*	*
mm-Kg	950	*	*	*	*	*	*	*	*	*
inch-lb	40	*	*	*	*	*	*	*	*	*
mm-Kg	1000	*	*	*	*	*	*	*	*	*
inch-lb	42	*	*	*	*	*	*	*	*	*
mm-Kg	1050	*	*	*	*	*	*	*	*	*
inch-lb	48	*	*	*	*	*	*	*	*	*
mm-Kg	1200	*	*	*	*	*	*	*	*	*
*	*	*	*	*	*	*	*	*	*	*
*	*	*	*	*	*	*	*	*	*	*



"All the above dimensions and weights could be subjected to changes by Perar SpA without any notification, due to engineering activities. Therefore, please consult the factory for confirmation on the above data as well as for other dimensions and weights not reported in the table".

ASME Class 300# Side Entry Welded Body

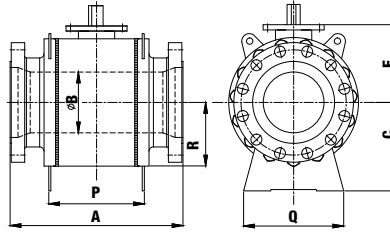

REDUCED BORE

REDUCED BORE

	SIZE	A(RF)	A(BW)	B	C	F	P	Q	R	WEIGHT
inch-lb	3x2	11,14	*	1,93	3,66	5,59	n.a.	n.a.	n.a.	*
mm-Kg	80x50	283	*	49	93	142	n.a.	n.a.	n.a.	*
inch-lb	4x3	12,01	*	2,91	4,33	6,61	n.a.	n.a.	n.a.	*
mm-Kg	100x80	305	*	74	110	168	n.a.	n.a.	n.a.	*
inch-lb	6x4	15,87	*	3,94	4,92	7,01	n.a.	n.a.	n.a.	*
mm-Kg	150x100	403	*	100	125	178	n.a.	n.a.	n.a.	*
inch-lb	8x6	19,76	*	5,91	6,50	9,25	10,24	10,08	9,29	*
mm-Kg	200x150	502	*	150	165	235	260	256	236	*
inch-lb	10x6	22,36	*	5,91	6,50	9,25	10,24	10,08	9,29	*
mm-Kg	250x150	568	*	150	165	235	260	256	236	*
inch-lb	10x8	22,36	*	7,91	7,64	10,63	13,58	12,60	11,57	*
mm-Kg	250x200	568	*	201	194	270	345	320	294	*
inch-lb	12x8	25,51	*	7,91	7,64	10,63	13,58	12,60	11,57	*
mm-Kg	300x200	648	*	201	194	270	345	320	294	*
inch-lb	12x10	25,51	*	9,92	8,78	11,22	14,02	13,62	12,48	*
mm-Kg	300x250	648	*	252	223	285	356	346	317	*
inch-lb	14x10	30,00	*	9,92	8,78	11,22	14,02	13,62	12,48	*
mm-Kg	350x250	762	*	252	223	285	356	346	317	*
inch-lb	14x12	30,00	*	11,93	10,91	13,86	16,14	17,72	15,00	*
mm-Kg	350x300	762	*	303	277	352	410	450	381	*
inch-lb	16x12	32,99	*	11,93	10,91	13,86	16,14	17,72	15,00	*
mm-Kg	400x300	838	*	303	277	352	410	450	381	*
inch-lb	16x14	32,99	*	13,15	12,01	14,88	17,95	19,69	16,14	*
mm-Kg	400x350	838	*	334	305	378	456	500	410	*

	SIZE	A(RF)	A(BW)	B	C	F	P	Q	R	WEIGHT
inch-lb	18x14	35,98	*	13,15	12,01	14,88	17,95	19,69	16,14	*
mm-Kg	450x350	914	*	334	305	378	456	500	410	*
inch-lb	18x16	35,98	*	15,16	13,70	16,69	20,98	22,05	19,29	*
mm-Kg	450x400	914	*	385	348	424	533	560	490	*
inch-lb	20x16	39,02	*	15,16	13,70	16,69	20,98	22,05	19,29	*
mm-Kg	500x400	991	*	385	348	424	533	560	490	*
inch-lb	20x18	39,02	*	17,17	14,96	18,03	23,70	24,65	20,16	*
mm-Kg	500x450	991	*	436	380	458	602	626	512	*
inch-lb	24x20	45,00	*	19,17	16,73	19,88	26,06	24,53	24,41	*
mm-Kg	600x500	1143	*	487	425	505	662	623	620	*
inch-lb	28x24	52,99	*	23,19	19,80	23,43	31,02	27,13	25,12	*
mm-Kg	700x600	1346	*	589	503	595	788	689	638	*
inch-lb	30x24	55,00	*	23,19	19,80	23,43	31,02	27,13	25,12	*
mm-Kg	750x600	1397	*	589	503	595	788	689	638	*
inch-lb	28x26	52,99	*	*	*	*	*	*	*	*
mm-Kg	700x650	1346	*	*	*	*	*	*	*	*
inch-lb	30x28	55,00	*	26,93	22,64	26,30	34,49	31,50	27,95	*
mm-Kg	750x700	1397	*	684	575	668	876	800	710	*
inch-lb	36x30	*	*	*	*	*	*	*	*	*
mm-Kg	900x750	*	*	*	*	*	*	*	*	*
inch-lb	36x32	*	*	*	*	*	*	*	*	*
mm-Kg	900x800	*	*	*	*	*	*	*	*	*
inch-lb	36x34	*	*	*	*	*	*	*	*	*
mm-Kg	900x850	*	*	*	*	*	*	*	*	*

"All the above dimensions and weights could be subjected to changes by Perar SpA without any notification, due to engineering activities. Therefore, please consult the factory for confirmation on the above data as well as for other dimensions and weights not reported in the table".



ASME Class 600# Side Entry Welded Body

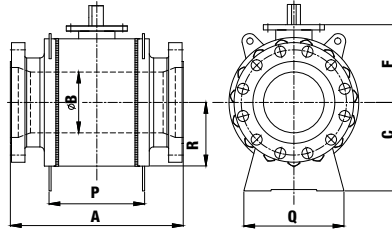

FULL BORE

FULL BORE

	SIZE	A(RF)	A(BW)	B	C	F	P	Q	R	WEIGHT
inch-lb	2	11,50	*	1,93	3,66	5,28	n.a.	n.a.	n.a.	*
mm-Kg	50	292	*	49	93	134	n.a.	n.a.	n.a.	*
inch-lb	3	14,02	*	2,91	4,33	6,61	n.a.	n.a.	n.a.	*
mm-Kg	80	356	*	74	110	168	n.a.	n.a.	n.a.	*
inch-lb	4	17,01	*	3,94	5,47	7,52	n.a.	n.a.	n.a.	*
mm-Kg	100	432	*	100	139	191	n.a.	n.a.	n.a.	*
inch-lb	6	22,01	*	5,91	6,50	9,25	10,98	9,96	10,43	*
mm-Kg	150	559	*	150	165	235	279	253	265	*
inch-lb	8	25,98	*	7,91	7,87	10,71	13,66	12,40	11,81	*
mm-Kg	200	660	*	201	200	272	347	315	300	*
inch-lb	10	30,98	26,54	9,92	9,33	12,24	16,14	13,86	13,39	1235
mm-Kg	250	787	674	252	237	311	410	352	340	560
inch-lb	12	32,99	29,02	11,93	10,91	13,86	18,82	17,80	14,65	1482
mm-Kg	300	838	737	303	277	352	478	452	372	672
inch-lb	14	35,00	30,98	13,15	12,40	15,24	18,11	20,47	16,54	2138
mm-Kg	350	889	787	334	315	387	460	520	420	970
inch-lb	16	39,02	32,99	15,16	13,82	16,81	20,98	21,77	19,29	2822
mm-Kg	400	991	838	385	351	427	533	553	490	1280
inch-lb	18	42,99	35,98	17,17	15,55	18,43	24,92	23,62	20,87	3483
mm-Kg	450	1092	914	436	395	468	633	600	530	1580
inch-lb	20	47,01	*	19,17	16,93	20,00	21,61	27,17	22,24	*
mm-Kg	500	1194	*	487	430	508	549	690	565	*
inch-lb	22	50,98	*	21,18	18,70	22,01	27,56	27,01	24,02	*
mm-Kg	550	1295	*	538	475	559	700	686	610	*

	SIZE	A(RF)	A(BW)	B	C	F	P	Q	R	WEIGHT
inch-lb	24	55,00	42,13	23,19	20,00	23,46	24,41	27,13	25,31	7275
mm-Kg	600	1397	1070	589	508	596	620	689	643	3300
inch-lb	26	57,01	*	24,92	21,57	25,00	25,59	31,50	26,89	*
mm-Kg	650	1448	*	633	548	635	650	800	683	*
inch-lb	28	60,98	*	26,93	22,76	26,26	27,13	33,07	27,95	*
mm-Kg	700	1549	*	684	578	667	689	840	710	*
inch-lb	30	65,00	49,02	28,94	24,80	29,53	25,39	36,14	30,12	12346
mm-Kg	750	1651	1245	735	630	750	645	918	765	5600
inch-lb	32	70,00	*	30,67	26,57	31,38	32,52	40,16	31,10	*
mm-Kg	800	1778	*	779	675	797	826	1020	790	*
inch-lb	34	75,98	*	32,68	27,17	31,89	40,59	40,35	32,87	*
mm-Kg	850	1930	*	830	690	810	1031	1025	835	*
inch-lb	36	82,01	56,50	34,41	29,06	33,70	35,51	51,18	34,45	18298
mm-Kg	900	2083	1435	874	738	856	902	1300	875	8300
inch-lb	38	*	*	*	*	*	*	*	*	*
mm-Kg	950	*	*	*	*	*	*	*	*	*
inch-lb	40	*	58,62	38,43	32,52	37,24	26,77	48,82	38,11	25353
mm-Kg	1000	*	1489	976	826	946	680	1240	968	11500
inch-lb	42	*	67,24	40,16	33,94	39,21	39,06	55,12	39,25	30865
mm-Kg	1050	*	1708	1020	862	996	992	1400	997	14000
inch-lb	48	*	76,57	45,91	38,39	43,78	39,37	59,06	43,70	41976
mm-Kg	1200	*	1945	1166	975	1112	1000	1500	1110	19040
*	*	*	*	*	*	*	*	*	*	*
*	*	*	*	*	*	*	*	*	*	*



ASME Class 600# Side Entry Welded Body

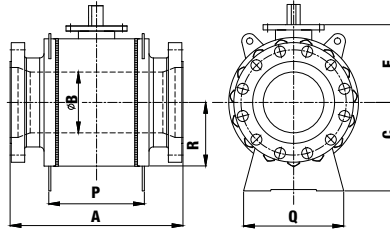

REDUCED BORE

REDUCED BORE

	SIZE	A(RF)	A(BW)	B	C	F	P	Q	R	WEIGHT
inch-lb	3x2	14,02	*	1,93	3,66	5,28	n.a.	n.a.	n.a.	*
mm-Kg	80x50	356	*	49	93	134	n.a.	n.a.	n.a.	*
inch-lb	4x3	17,01	*	2,91	4,33	6,61	n.a.	n.a.	n.a.	*
mm-Kg	100x80	432	*	74	110	168	n.a.	n.a.	n.a.	*
inch-lb	6x4	22,01	*	3,94	5,47	7,52	n.a.	n.a.	n.a.	*
mm-Kg	150x100	559	*	100	139	191	n.a.	n.a.	n.a.	*
inch-lb	8x6	25,98	*	5,91	6,50	9,25	10,98	9,96	10,43	*
mm-Kg	200x150	660	*	150	165	235	279	253	265	*
inch-lb	10x6	30,98	*	5,91	6,50	9,25	10,98	9,96	10,43	*
mm-Kg	250x150	787	*	150	165	235	279	253	265	*
inch-lb	10x8	30,98	*	7,91	7,87	10,71	13,66	12,40	11,81	*
mm-Kg	250x200	787	*	201	200	272	347	315	300	*
inch-lb	12x8	32,99	*	7,91	7,87	10,71	13,66	12,40	11,81	*
mm-Kg	300x200	838	*	201	200	272	347	315	300	*
inch-lb	12x10	32,99	*	9,92	9,33	12,24	16,14	13,86	13,39	*
mm-Kg	300x250	838	*	252	237	311	410	352	340	*
inch-lb	14x10	35,00	*	9,92	9,33	12,24	16,14	13,86	13,39	*
mm-Kg	350x250	889	*	252	237	311	410	352	340	*
inch-lb	14x12	35,00	*	11,93	10,91	13,86	18,82	17,80	14,65	*
mm-Kg	350x300	889	*	303	277	352	478	452	372	*
inch-lb	16x12	39,02	*	11,93	10,91	13,86	18,82	17,80	14,65	*
mm-Kg	400x300	991	*	303	277	352	478	452	372	*
inch-lb	16x14	39,02	*	13,15	12,40	15,24	18,11	20,47	16,54	*
mm-Kg	400x350	991	*	334	315	387	460	520	420	*
inch-lb	18x14	42,99	*	13,15	12,40	15,24	18,11	20,47	16,54	*
mm-Kg	450x350	1092	*	334	315	387	460	520	420	*

	SIZE	A(RF)	A(BW)	B	C	F	P	Q	R	WEIGHT
inch-lb	18x16	42,99	*	15,16	13,82	16,81	20,98	21,77	19,29	*
mm-Kg	450x400	1092	*	385	351	427	533	553	490	*
inch-lb	20x16	47,01	*	15,16	13,82	16,81	20,98	21,77	19,29	*
mm-Kg	500x400	1194	*	385	351	427	533	553	490	*
inch-lb	20x18	47,01	*	17,17	15,55	18,43	24,92	23,62	20,87	*
mm-Kg	500x450	1194	*	436	395	468	633	600	530	*
inch-lb	24x20	55,00	*	19,17	16,93	20,00	21,61	27,17	22,24	*
mm-Kg	600x500	1397	*	487	430	508	549	690	565	*
inch-lb	28x24	60,98	*	23,19	20,00	23,46	24,41	27,13	25,31	*
mm-Kg	700x600	1549	*	589	508	596	620	689	643	*
inch-lb	30x24	65,00	*	23,19	20,00	23,46	24,41	27,13	25,31	*
mm-Kg	750x600	1651	*	589	508	596	620	689	643	*
inch-lb	28x26	60,98	*	24,92	21,57	25,00	25,59	31,50	26,89	*
mm-Kg	700x650	1549	*	633	548	635	650	800	683	*
inch-lb	30x26	65,00	*	24,92	21,57	25,00	25,59	31,50	26,89	*
mm-Kg	750x650	1651	*	633	548	635	650	800	683	*
inch-lb	30x28	65,00	*	26,93	22,76	26,26	27,13	33,07	27,95	*
mm-Kg	750x700	1651	*	684	578	667	689	840	710	*
inch-lb	36x30	82,01	*	28,94	24,80	29,53	25,39	36,14	30,12	*
mm-Kg	900x750	2083	*	735	630	750	645	918	765	*
inch-lb	36x32	82,01	*	30,67	26,57	31,38	32,52	40,16	31,10	*
mm-Kg	900x800	2083	*	779	675	797	826	1020	790	*
inch-lb	36x34	82,01	*	*	*	*	*	*	*	*
mm-Kg	900x850	2083	*	*	*	*	*	*	*	*
*	*	*	*	*	*	*	*	*	*	*
*	*	*	*	*	*	*	*	*	*	*

"All the above dimensions and weights could be subjected to changes by Perar SpA without any notification, due to engineering activities. Therefore, please consult the factory for confirmation on the above data as well as for other dimensions and weights not reported in the table".



ASME Class 900# Side Entry Welded Body

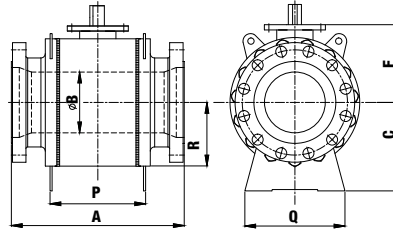

FULL BORE

REDUCED BORE

	SIZE	A(RF)	A(BW)	B	C	F	P	Q	R	WEIGHT
inch-lb	2	14,61	*	1,93	3,66	5,59	n.a.	n.a.	n.a.	*
mm-Kg	50	371	*	49	93	142	n.a.	n.a.	n.a.	*
inch-lb	3	15,12	*	2,91	4,61	6,69	n.a.	n.a.	n.a.	*
mm-Kg	80	384	*	74	117	170	n.a.	n.a.	n.a.	*
inch-lb	4	18,11	*	3,94	5,47	7,52	n.a.	n.a.	n.a.	*
mm-Kg	100	460	*	100	139	191	n.a.	n.a.	n.a.	*
inch-lb	6	24,13	*	5,91	6,50	9,41	10,94	10,04	8,70	*
mm-Kg	150	613	*	150	165	239	278	255	221	*
inch-lb	8	29,13	*	7,91	8,58	11,18	14,17	13,70	12,40	*
mm-Kg	200	740	*	201	218	284	360	348	315	*
inch-lb	10	33,11	*	9,92	10,16	12,80	14,57	16,06	13,98	*
mm-Kg	250	841	*	252	258	325	370	408	355	*
inch-lb	12	38,11	*	11,93	11,81	14,57	15,94	17,32	15,67	*
mm-Kg	300	968	*	303	300	370	405	440	398	*
inch-lb	14	40,87	*	12,68	12,44	15,43	19,29	19,29	17,76	*
mm-Kg	350	1038	*	322	316	392	490	490	451	*
inch-lb	16	44,88	*	14,69	14,37	17,32	21,73	24,41	19,69	*
mm-Kg	400	1140	*	373	365	440	552	620	500	*
inch-lb	18	48,50	*	16,65	16,14	19,61	27,24	27,56	21,46	*
mm-Kg	450	1232	*	423	410	498	692	700	545	*
inch-lb	20	52,52	*	18,54	17,64	20,51	22,64	27,17	22,83	*
mm-Kg	500	1334	*	471	448	521	575	690	580	*
inch-lb	22	*	*	*	*	*	*	*	*	*
mm-Kg	550	*	*	*	*	*	*	*	*	*
inch-lb	24	61,73	*	22,44	20,87	24,69	32,36	33,46	26,18	*
mm-Kg	600	1568	*	570	530	627	822	850	665	*
inch-lb	26	65,87	*	24,29	22,83	26,61	26,38	32,68	28,15	*
mm-Kg	650	1673	*	617	580	676	670	830	715	*
inch-lb	28	*	*	*	*	*	*	*	*	*
mm-Kg	700	*	*	*	*	*	*	*	*	*
inch-lb	30	74,88	*	28,03	25,79	29,53	27,95	40,94	31,38	*
mm-Kg	750	1902	*	712	655	750	710	1040	797	*
inch-lb	32	*	*	*	*	*	*	*	*	*
mm-Kg	800	*	*	*	*	*	*	*	*	*
inch-lb	34	*	*	*	*	*	*	*	*	*
mm-Kg	850	*	*	*	*	*	*	*	*	*
inch-lb	36	91,14	*	33,66	31,50	32,64	36,61	51,18	36,81	*
mm-Kg	900	2315	*	855	800	829	930	1300	935	*
*	*	*	*	*	*	*	*	*	*	*
*	*	*	*	*	*	*	*	*	*	*
*	*	*	*	*	*	*	*	*	*	*
*	*	*	*	*	*	*	*	*	*	*
*	*	*	*	*	*	*	*	*	*	*
*	*	*	*	*	*	*	*	*	*	*
*	*	*	*	*	*	*	*	*	*	*
*	*	*	*	*	*	*	*	*	*	*
*	*	*	*	*	*	*	*	*	*	*
*	*	*	*	*	*	*	*	*	*	*
*	*	*	*	*	*	*	*	*	*	*
*	*	*	*	*	*	*	*	*	*	*
*	*	*	*	*	*	*	*	*	*	*
*	*	*	*	*	*	*	*	*	*	*
*	*	*	*	*	*	*	*	*	*	*
*	*	*	*	*	*	*	*	*	*	*
*	*	*	*	*	*	*	*	*	*	*
*	*	*	*	*	*	*	*	*	*	*

	SIZE	A(RF)	A(BW)	B	C	F	P	Q	R	WEIGHT
inch-lb	3x2	15,12	*	1,93	3,66	5,59	n.a.	n.a.	n.a.	*
mm-Kg	80x50	384	*	49	93	142	n.a.	n.a.	n.a.	*
inch-lb	4x3	18,11	*	2,91	4,61	6,69	n.a.	n.a.	n.a.	*
mm-Kg	100x80	460	*	74	117	170	n.a.	n.a.	n.a.	*
inch-lb	6x4	24,13	*	3,94	5,47	7,52	n.a.	n.a.	n.a.	*
mm-Kg	150x100	613	*	100	139	191	n.a.	n.a.	n.a.	*
inch-lb	8x6	29,13	*	5,91	6,50	9,41	10,94	10,04	8,70	*
mm-Kg	200x150	740	*	150	165	239	278	255	221	*
inch-lb	10x6	33,11	*	5,91	6,50	9,41	10,94	10,04	8,70	*
mm-Kg	250x150	841	*	150	165	239	278	255	221	*
inch-lb	10x8	33,11	*	7,91	8,58	11,18	14,17	13,70	12,40	*
mm-Kg	250x200	841	*	201	218	284	360	348	315	*
inch-lb	12x8	38,11	*	7,91	8,58	11,18	14,17	13,70	12,40	*
mm-Kg	300x200	968	*	201	218	284	360	348	315	*
inch-lb	12x10	38,11	*	9,92	10,16	12,80	14,57	16,06	13,98	*
mm-Kg	300x250	968	*	252	258	325	370	408	355	*
inch-lb	14x10	40,87	*	9,92	10,16	12,80	14,57	16,06	13,98	*
mm-Kg	350x250	1038	*	252	258	325	370	408	355	*
inch-lb	14x12	40,87	*	11,93	11,81	14,57	15,94	17,32	15,67	*
mm-Kg	350x300	1038	*	303	300	370	405	440	398	*
inch-lb	16x12	44,88	*	11,93	11,81	14,57	15,94	17,32	15,67	*
mm-Kg	400x300	1140	*	303	300	370	405	440	398	*
inch-lb	16x14	44,88	*	12,68	12,44	15,43	19,29	19,29	17,76	*
mm-Kg	400x350	1140	*	322	316	392	490	490	451	*
inch-lb	18x14	48,50	*	12,68	12,44	15,43	19,29	19,29	17,76	*
mm-Kg	450x350	1232	*	322	316	392	490	490	451	*
inch-lb	18x16	48,50	*	14,69	14,37	17,32	21,73	24,41	19,69	*
mm-Kg	450x400	1232	*	373	365	440	552	620	500	*
inch-lb	20x16	52,52	*	14,69	14,37	17,32	21,73	24,41	19,69	*
mm-Kg	500x400	1334	*	373	365	440	552	620	500	*
inch-lb	20x18	52,52	*	16,65	16,14	19,61	27,24	27,56	21,46	*
mm-Kg	500x450	1334	*	423	410	498	692	700	545	*
inch-lb	24x20	61,73	*	18,54	17,64	20,51	22,64	27,17	22,83	*
mm-Kg	600x500	1568	*	471	448	521	575	690	580	*
inch-lb	30x24	74,88	*	22,44	20,87	24,69	32,36	33,46	26,18	*
mm-Kg	750x600	1902	*	570	530	627	822	850	665	*
inch-lb	28x26	*	*	24,29	22,83	26,61	26,38	32,68	28,15	*
mm-Kg	700x650	*	*	617	580	676	670	830	715	*
inch-lb	30x26	74,88	*	24,29	22,83	26,61	26,38	32,68	28,15	*
mm-Kg	750x650	1902	*	617	580	676	670	830	715	*
inch-lb	36x30	91,14	*	28,03	25,79	29,53	27,95	40,94	31,38	*
mm-Kg	900x750	2315	*	712	655	750	710	1040	797	*
inch-lb	36x32	91,14	*	*	*	*	*	*	*	*
mm-Kg	900x800	2315	*	*	*	*	*	*	*	*
inch-lb	36x34	91,14	*	*	*	*	*	*	*	*
mm-Kg	900x850	2315	*	*	*	*	*	*	*	*

"All the above dimensions and weights could be subjected to changes by Perar SpA without any notification, due to engineering activities. Therefore, please consult the factory for confirmation on the above data as well as for other dimensions and weights not reported in the table".



ASME Class 1500# Side Entry Welded Body

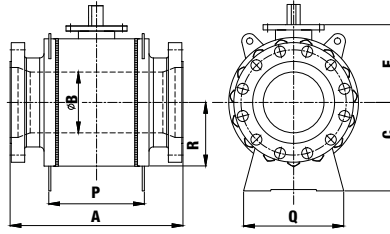

FULL BORE

REDUCED BORE

	SIZE	A(RF)	A(BW)	B	C	F	P	Q	R	WEIGHT
inch-lb	2	14,61	*	1,93	3,94	5,87	n.a.	n.a.	n.a.	*
mm-Kg	50	371	*	49	100	149	n.a.	n.a.	n.a.	*
inch-lb	3	18,62	*	2,91	4,84	7,01	n.a.	n.a.	n.a.	*
mm-Kg	80	473	*	74	123	178	n.a.	n.a.	n.a.	*
inch-lb	4	21,61	*	3,94	5,51	8,39	n.a.	n.a.	n.a.	*
mm-Kg	100	549	*	100	140	213	n.a.	n.a.	n.a.	*
inch-lb	6	27,99	*	5,67	8,07	10,75	13,78	13,70	11,81	*
mm-Kg	150	711	*	144	205	273	350	348	300	*
inch-lb	8	33,11	*	7,56	9,65	12,64	14,96	16,34	13,78	*
mm-Kg	200	841	*	192	245	321	380	415	350	*
inch-lb	10	*	*	*	*	*	*	*	*	*
mm-Kg	250	*	*	*	*	*	*	*	*	*
inch-lb	12	*	*	*	*	*	*	*	*	*
mm-Kg	300	*	*	*	*	*	*	*	*	*
inch-lb	14	50,24	*	12,40	14,57	19,45	19,57	23,58	19,92	*
mm-Kg	350	1276	*	315	370	494	497	599	506	*
inch-lb	16	55,39	*	14,17	16,06	20,94	22,68	23,62	21,65	*
mm-Kg	400	1407	*	360	408	532	576	600	550	*
inch-lb	18	61,38	*	15,98	18,03	22,64	24,41	30,31	23,62	*
mm-Kg	450	1559	*	406	458	575	620	770	600	*
inch-lb	20	66,38	*	17,87	20,59	25,31	24,41	34,25	26,18	*
mm-Kg	500	1686	*	454	523	643	620	870	665	*
inch-lb	22	*	*	*	*	*	*	*	*	*
mm-Kg	550	*	*	*	*	*	*	*	*	*
inch-lb	24	*	*	*	*	*	*	*	*	*
mm-Kg	600	*	*	*	*	*	*	*	*	*
*	*	*	*	*	*	*	*	*	*	*
*	*	*	*	*	*	*	*	*	*	*

	SIZE	A(RF)	A(BW)	B	C	F	P	Q	R	WEIGHT
inch-lb	3x2	18,62	*	1,93	3,94	5,87	n.a.	n.a.	n.a.	*
mm-Kg	80x50	473	*	49	100	149	n.a.	n.a.	n.a.	*
inch-lb	4x3	21,61	*	2,91	4,84	7,01	n.a.	n.a.	n.a.	*
mm-Kg	100x80	549	*	74	123	178	n.a.	n.a.	n.a.	*
inch-lb	6x4	27,99	*	3,94	5,51	8,39	n.a.	n.a.	n.a.	*
mm-Kg	150x100	711	*	100	140	213	n.a.	n.a.	n.a.	*
inch-lb	8x6	33,11	*	5,67	8,07	10,75	13,78	13,70	11,81	*
mm-Kg	200x150	841	*	144	205	273	350	348	300	*
inch-lb	10x6	39,37	*	5,67	8,07	10,75	13,78	13,70	11,81	*
mm-Kg	250x150	1000	*	144	205	273	350	348	300	*
inch-lb	10x8	39,37	*	7,56	9,65	12,64	14,96	16,34	13,78	*
mm-Kg	250x200	1000	*	192	245	321	380	415	350	*
inch-lb	12x10	*	*	*	*	*	*	*	*	*
mm-Kg	300x250	*	*	*	*	*	*	*	*	*
inch-lb	16x12	*	*	*	*	*	*	*	*	*
mm-Kg	400x300	*	*	*	*	*	*	*	*	*
inch-lb	16x14	*	*	*	*	*	*	*	*	*
mm-Kg	400x350	*	*	*	*	*	*	*	*	*
inch-lb	18x14	*	*	*	*	*	*	*	*	*
mm-Kg	450x350	*	*	*	*	*	*	*	*	*
inch-lb	18x16	61,38	*	14,17	16,06	20,94	22,68	23,62	21,65	*
mm-Kg	450x400	1559	*	360	408	532	576	600	550	*
inch-lb	20x16	66,38	*	14,17	16,06	20,94	22,68	23,62	21,65	*
mm-Kg	500x400	1686	*	360	408	532	576	600	550	*
inch-lb	20x18	66,38	*	15,98	18,03	22,64	24,41	30,31	23,62	*
mm-Kg	500x450	1686	*	406	458	575	620	770	600	*
inch-lb	24x20	77,64	*	17,87	20,59	25,31	24,41	34,25	26,18	*
mm-Kg	600x500	1972	*	454	523	643	620	870	665	*

"All the above dimensions and weights could be subjected to changes by Perar SpA without any notification, due to engineering activities. Therefore, please consult the factory for confirmation on the above data as well as for other dimensions and weights not reported in the table".



ASME Class 2500# Side Entry Welded Body

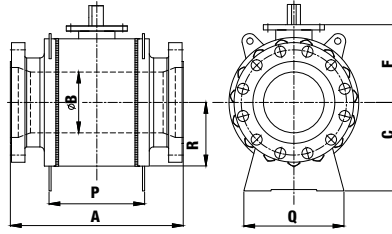

FULL BORE

REDUCED BORE

	SIZE	A(RF)	A(BW)	B	C	F	P	Q	R	WEIGHT
inch-lb	2	17,87	*	1,65	4,65	6,81	n.a.	n.a.	n.a.	287
mm-Kg	50	454	*	42	118	173	n.a.	n.a.	n.a.	130
inch-lb	3	22,99	*	2,44	5,20	7,36	n.a.	n.a.	n.a.	*
mm-Kg	80	584	*	62	132	187	n.a.	n.a.	n.a.	*
inch-lb	4	*	*	*	*	*	n.a.	n.a.	n.a.	*
mm-Kg	100	*	*	*	*	*	n.a.	n.a.	n.a.	*
inch-lb	6	36,50	*	5,16	9,17	12,28	15,20	15,20	13,46	1698
mm-Kg	150	927	*	131	233	312	386	386	342	770
inch-lb	8	40,87	*	7,05	11,22	14,88	17,52	17,95	15,35	*
mm-Kg	200	1038	*	179	285	378	445	456	390	*
inch-lb	10	50,87	*	8,78	13,50	17,95	22,64	21,54	17,32	*
mm-Kg	250	1292	*	223	343	456	575	547	440	*
inch-lb	12	*	*	*	*	*	*	*	*	*
mm-Kg	300	*	*	*	*	*	*	*	*	*
*	*	*	*	*	*	*	*	*	*	*
*	*	*	*	*	*	*	*	*	*	*

	SIZE	A(RF)	A(BW)	B	C	F	P	Q	R	WEIGHT
inch-lb	3x2	22,99	*	1,65	4,65	6,81	n.a.	n.a.	n.a.	*
mm-Kg	80x50	584	*	42	118	173	n.a.	n.a.	n.a.	*
inch-lb	4x3	26,89	*	2,44	5,20	7,36	n.a.	n.a.	n.a.	*
mm-Kg	100x80	683	*	62	132	187	n.a.	n.a.	n.a.	*
inch-lb	6x4	*	*	*	*	*	n.a.	n.a.	n.a.	*
mm-Kg	150x100	*	*	*	*	*	n.a.	n.a.	n.a.	*
inch-lb	8x6	40,87	*	5,16	9,17	12,28	15,20	15,20	13,46	*
mm-Kg	200x150	1038	*	131	233	312	386	386	342	*
inch-lb	10x6	50,87	*	5,16	9,17	12,28	15,20	15,20	13,46	*
mm-Kg	250x150	1292	*	131	233	312	386	386	342	*
inch-lb	10x8	50,87	*	7,05	11,22	14,88	17,52	17,95	15,35	*
mm-Kg	250x200	1292	*	179	285	378	445	456	390	*
inch-lb	12x8	56,89	*	7,05	11,22	14,88	17,52	17,95	15,35	*
mm-Kg	300x200	1445	*	179	285	378	445	456	390	*
inch-lb	12x10	56,89	*	8,78	13,50	17,95	22,64	21,54	17,32	*
mm-Kg	300x250	1445	*	223	343	456	575	547	440	*



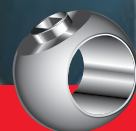



Perar

Trunnion Mounted Top Entry Ball Valves



Perar
THAT'S
QUALITY

The Best Guarantee of Safety

Perar



Component Parts

Part No.	Description
01	Body
03	Seat Ring
04	Ball
06	Stem
07	Upper Thrust Washer
09a	Body Gasket
09d	Bonnet O-Ring
10a	Gland Plate Stud
16	Stem O-Ring
16a	Stem Gasket
17a	Gland Plate Nut
24	Body Stud
25	Body Stud Nut
27a	Ball Bearing
28a	Upper Thrust Washer
28b	Lower Thrust Washer
30	Gland Plate
31	Gland Plate Gasket
32	Gland Plate O-Ring
34	Drain Plug
35	Vent Valve
37	Seat O-Ring
39c	Adapter Plate Stud
50	Bonnet
53	Spring Holder Ring
69	Stem Key Screw
70	Stem Key
77	Adapter Plate Pin
77a	Gland Plate Pin
78	Bonnet Pin
99	Adapter Plate

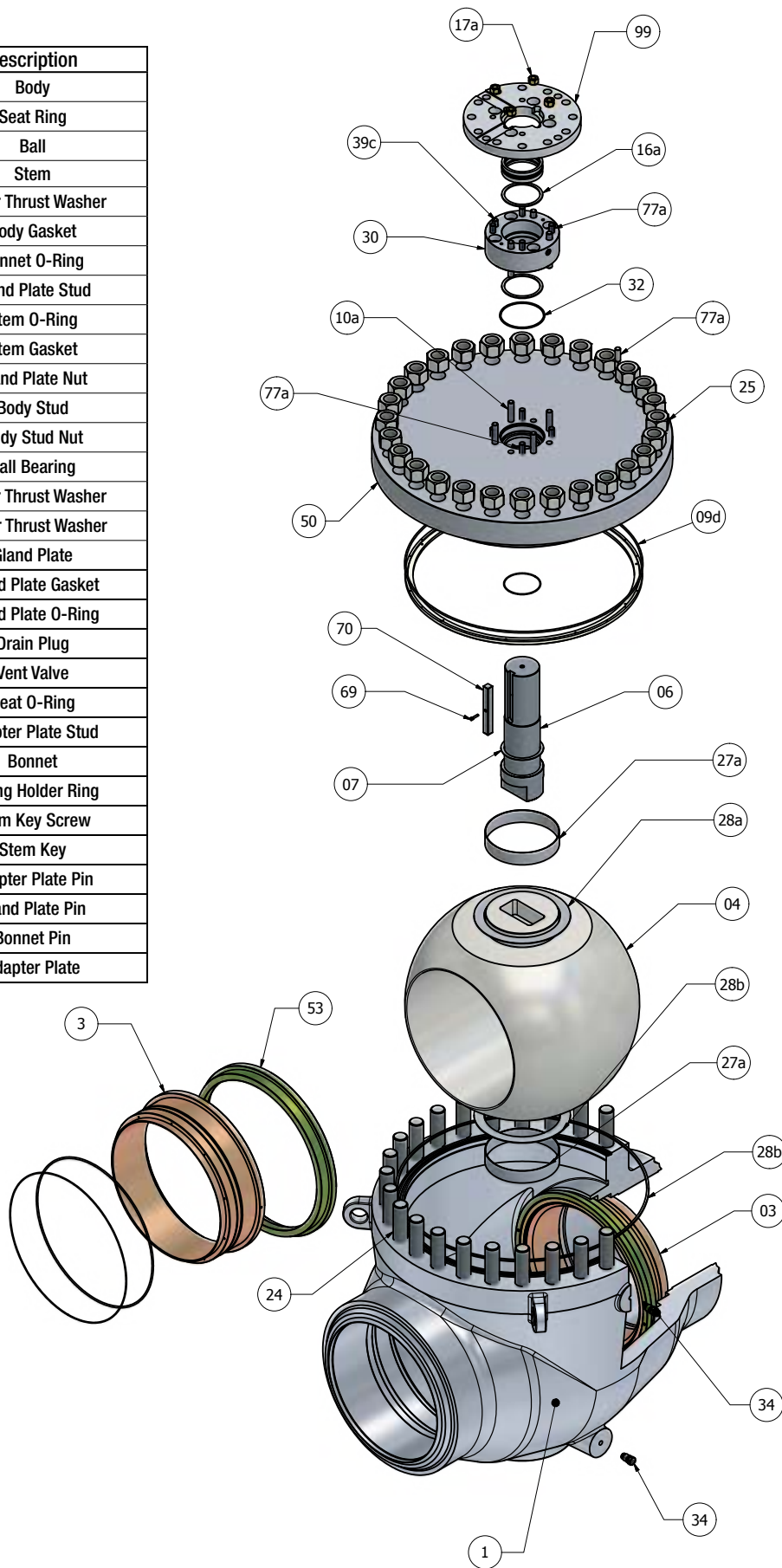

Valve Material Selection

BODY, CLOSURE

CS (ASTM A105, ASTM A216), LTCS (ASTM A350 LF2, ASTM A352)
High strength LTCS (A694 F52, F60, F65)
Austenitic SS (ASTM A182 F304, F316, ASTM A351 CF3, CF3M, CF8, CF8M)
Duplex SS 22% Cr (ASTM A182 F51, ASTM A890, A995)
Superduplex SS 25% Cr (ASTM A182 F53/F55, ASTM A890, A995)
6Mo SS (ASTM A182 F44, ASTM)
Inconel 625
Incoloy 825
Monel

TRIM (SEAT, BALL AND STEM)

CS (ASTM A105), LTCS (ASTM A350 LF2) + ENP 0.003"
High strength LTCS (A694 F52, F60, F65) + ENP 0.003"
AISI 410 Martensitic SS (ASTM A182 F6a)
17-4 PH
Austenitic SS (ASTM A182 F304, F316)
Duplex SS 22% Cr (ASTM A182-F51)
Superduplex SS 25% Cr (ASTM A182 F53/F55)
6Mo SS (ASTM A182 F44)
Inconel 625
Inconel 718
Incoloy 825
Monel

BODY SEALS / SEAT SEALS

Viton A FKM O-ring
Viton GLT FKM O-ring
Viton AED FKM O-ring
HNBR O-ring
FFKM O-ring
PTFE + ELGILOY Lip-Seals
Graphite Packing / Gaskets

SEAT INSERT

Viton A/GLT/AED FKM
HNBR
PTFE / RPTFE
Nylon / DEVLON V
PCTFE / KEL-F
PEEK
METAL with either Tungsten Carbide or Chromium Carbide Coating (0.15 mm min. thk.)

BOLTING

ASTM A193 B7/B7M, ASTM A320 L7/L7M
A193/A320 B8/B8M
UNS S31803, UNS S32760, ASTM A453-GR.660



ASME Class 150# Top Entry Body Full Bore

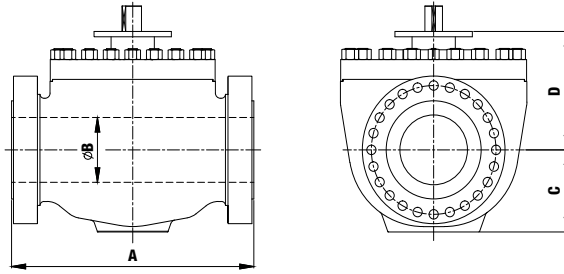

	SIZE	A(RF)	A(BW)	B	C	D	NOTE			WEIGHT								
inch-lb	2	11,50	11,50	1,93	3,27	8,27				64								
mm-Kg	50	292	292	49	83	210				29								
inch-lb	3	14,02	14,02	2,91	4,33	8,86				123								
mm-Kg	80	356	356	74	110	225				56								
inch-lb	4	17,01	17,01	3,94	5,63	10,83				225								
mm-Kg	100	432	432	100	143	275				102								
inch-lb	6	22,01	22,01	5,91	8,54	10,94				492								
mm-Kg	150	559	559	150	217	278				223								
inch-lb	8	25,98	25,98	7,91	10,39	12,68				904								
mm-Kg	200	660	660	201	264	322				410								
inch-lb	10	30,98	30,98	9,92	12,32	14,06				1003								
mm-Kg	250	787	787	252	313	357				455								
inch-lb	12	32,99	32,99	11,93	15,75	18,90				1294								
mm-Kg	300	838	838	303	400	480				587								
inch-lb	14	35,00	35,00	13,15	16,93	17,91				1664								
mm-Kg	350	889	889	334	430	455				755								
inch-lb	16	39,02	39,02	15,16	17,80	18,23				2469								
mm-Kg	400	991	991	385	452	463				1120								
inch-lb	18	42,99	42,99	17,17	18,50	19,69				3347								
mm-Kg	450	1092	1092	436	470	500				1518								
inch-lb	20	47,01	47,01	19,17	22,95	21,85				4295								
mm-Kg	500	1194	1194	487	583	555				1948								
inch-lb	22	50,98	50,98	21,18	23,23	22,17				6056								
mm-Kg	550	1295	1295	538	590	563				2747								
inch-lb	24	55,00	55,00	23,19	23,39	23,62				7092								
mm-Kg	600	1397	1397	589	594	600				3217								
inch-lb	26	57,01	57,01	24,92	24,80	26,38				8569								
mm-Kg	650	1448	1448	633	630	670				3887								
inch-lb	28	60,98	60,98	26,93	27,72	28,86				10174								
mm-Kg	700	1549	1549	684	704	733				4615								
inch-lb	30	65,00	65,00	28,94	30,35	31,38				12522								
mm-Kg	750	1651	1651	735	771	797				5680								
inch-lb	32	70,00	70,00	30,67	32,56	33,31				15653								
mm-Kg	800	1778	1778	779	827	846				7100								
inch-lb	34	75,98	75,98	32,68	34,80	34,29				17240								
mm-Kg	850	1930	1930	830	884	871				7820								
inch-lb	36	82,01	82,01	34,41	36,89	36,65				20194								
mm-Kg	900	2083	2083	874	937	931				9160								
inch-lb	40	92,01	92,01	38,43	40,75	39,76				28241								
mm-Kg	1000	2337	2337	976	1035	1010				12810								
inch-lb	42	90,00	*	40,16	37,20	39,61	256/10			46716								
mm-Kg	1050	2286	*	1020	945	1006				21190								
inch-lb	48	100,00	100,00	45,91	48,43	464,57				49758								
mm-Kg	1200	2540	2540	1166	1230	11800				22570								



ASME Class 300# Top Entry Body Full Bore

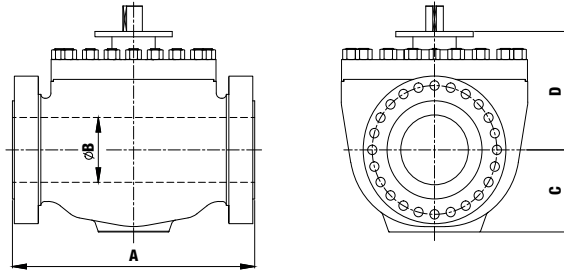

	SIZE	A(RF)	A(BW)	B	C	D	NOTE			WEIGHT								
inch-lb	2	11,50	11,50	1,93	3,27	8,27				73								
mm-Kg	50	292	292	49	83	210				33								
inch-lb	3	14,02	14,02	2,91	4,33	8,86				146								
mm-Kg	80	356	356	74	110	225				66								
inch-lb	4	17,01	17,01	3,94	5,63	10,83				265								
mm-Kg	100	432	432	100	143	275				120								
inch-lb	6	22,01	22,01	5,91	8,54	10,94				562								
mm-Kg	150	559	559	150	217	278				255								
inch-lb	8	25,98	25,98	7,91	8,66	13,39	012/13			1063								
mm-Kg	200	660	660	201	220	340				482								
inch-lb	10	30,98	30,98	9,92	12,32	14,57				1179								
mm-Kg	250	787	787	252	313	370				535								
inch-lb	12	32,99	32,99	11,93	15,75	19,41				1488								
mm-Kg	300	838	838	303	400	493				675								
inch-lb	14	35,00	35,00	13,15	16,93	18,50				1940								
mm-Kg	350	889	889	334	430	470				880								
inch-lb	16	39,02	39,02	15,16	17,80	18,70				2884								
mm-Kg	400	991	991	385	452	475				1308								
inch-lb	18	42,99	42,99	17,17	16,22	20,94	286/07			5071								
mm-Kg	450	1092	1092	436	412	532				2300								
inch-lb	20	47,01	47,01	19,17	18,90	22,13	286/07			6305								
mm-Kg	500	1194	1194	487	480	562				2860								
inch-lb	22	50,98	50,98	21,18	23,23	23,35				7136								
mm-Kg	550	1295	1295	538	590	593				3237								
inch-lb	24	55,00	55,00	23,19	23,39	25,00				8223								
mm-Kg	600	1397	1397	589	594	635				3730								
inch-lb	26	57,01	57,01	24,92	24,80	27,24				9954								
mm-Kg	650	1448	1448	633	630	692				4515								
inch-lb	28	60,98	60,98	26,93	27,72	29,92				11982								
mm-Kg	700	1549	1549	684	704	760				5435								
inch-lb	30	65,00	65,00	28,94	30,35	32,44				14738								
mm-Kg	750	1651	1651	735	771	824				6685								
inch-lb	32	70,00	70,00	30,67	32,56	34,65				18409								
mm-Kg	800	1778	1778	779	827	880				8350								
inch-lb	34	75,98	75,98	32,68	34,80	35,63				20183								
mm-Kg	850	1930	1930	830	884	905				9155								
inch-lb	36	82,01	82,01	34,41	38,19	36,89				23634								
mm-Kg	900	2083	2083	874	970	937				10720								
inch-lb	40	92,01	92,01	38,43	40,75	41,34				33080								
mm-Kg	1000	2337	2337	976	1035	1050				15005								
inch-lb	42	95,94	95,94	40,16	42,24	43,31				38890								
mm-Kg	1050	2437	2437	1020	1073	1100				17640								
inch-lb	48	100,00	100,00	45,91	48,43	48,03				58301								
mm-Kg	1200	2540	2540	1166	1230	1220				26445								

"All the above dimensions and weights could be subjected to changes by Perar SpA without any notification, due to engineering activities. Therefore, please consult the factory for confirmation on the above data as well as for other dimensions and weights not reported in the table".



ASME Class 600# Top Entry Body Full Bore

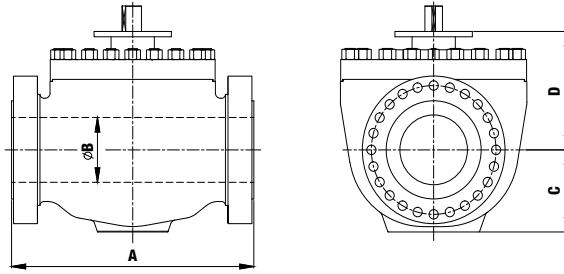

	SIZE	A(RF)	A(BW)	B	C	D	NOTE		WEIGHT									
inch-lb	2	11,50	11,50	1,93	3,27	8,27			84									
mm-Kg	50	292	292	49	83	210			38									
inch-lb	3	14,02	14,02	2,91	4,33	8,86			154									
mm-Kg	80	356	356	74	110	225			70									
inch-lb	4	17,01	17,01	3,94	5,63	10,83			298									
mm-Kg	100	432	432	100	143	275			135									
inch-lb	6	22,01	22,01	5,91	8,54	10,94			622									
mm-Kg	150	559	559	150	217	278			282									
inch-lb	8	25,98	25,98	7,91	10,39	12,99			1184									
mm-Kg	200	660	660	201	264	330			537									
inch-lb	10	30,98	30,98	9,92	12,32	14,57			1477									
mm-Kg	250	787	787	252	313	370			670									
inch-lb	12	32,99	32,99	11,93	11,61	16,06	perar		1257									
mm-Kg	300	838	838	303	295	408			570									
inch-lb	14	35,00	35,00	13,15	12,60	17,01	perar		2509									
mm-Kg	350	889	889	334	320	432			1138									
inch-lb	16	39,02	39,02	15,16	17,80	20,08			3642									
mm-Kg	400	991	991	385	452	510			1652									
inch-lb	18	42,99	42,99	17,17	18,50	21,65			4998									
mm-Kg	450	1092	1092	436	470	550			2267									
inch-lb	20	47,01	47,01	19,17	17,72	22,44	122/10		6305									
mm-Kg	500	1194	1194	487	450	570			2860									
inch-lb	22	50,98	50,98	21,18	23,23	24,61			9039									
mm-Kg	550	1295	1295	538	590	625			4100									
inch-lb	24	55,00	55,00	23,19	20,87	28,35	058/09		10604									
mm-Kg	600	1397	1397	589	530	720			4810									
inch-lb	26	57,01	57,01	24,92	24,80	28,46			12721									
mm-Kg	650	1448	1448	633	630	723			5770									
inch-lb	28	60,98	60,98	26,93	27,72	31,10			15322									
mm-Kg	700	1549	1549	684	704	790			6950									
inch-lb	30	65,00	65,00	28,94	25,59	32,80	perar		18850									
mm-Kg	750	1651	1651	735	650	833			8550									
inch-lb	32	70,00	70,00	30,67	32,56	36,22			23413									
mm-Kg	800	1778	1778	779	827	920			10620									
inch-lb	34	75,98	75,98	32,68	34,80	37,40			25794									
mm-Kg	850	1930	1930	830	884	950			11700									
inch-lb	36	82,01	82,01	34,41	36,89	39,57			30247									
mm-Kg	900	2083	2083	874	937	1005			13720									
inch-lb	40	92,01	92,01	38,43	40,75	42,72			42307									
mm-Kg	1000	2337	2337	976	1035	1085			19190									
inch-lb	42	95,94	95,94	40,16	42,24	44,57			48766									
mm-Kg	1050	2437	2437	1020	1073	1132			22120									
inch-lb	48	100,00	100,00	45,91	48,43	49,61			70570									
mm-Kg	1200	2540	2540	1166	1230	1260			32010									



ASME Class 900# Top Entry Body Full Bore

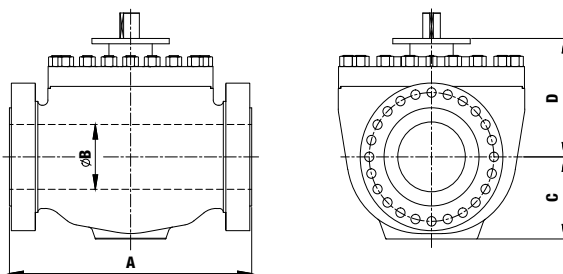

	SIZE	A(RF)	A(BW)	B	C	D	NOTE			WEIGHT								
inch-lb	2	14,61	14,49	1,93	3,27	8,27				117								
mm-Kg	50	371	368	49	83	210				53								
inch-lb	3	15,12	15,00	2,91	4,33	8,86				247								
mm-Kg	80	384	381	74	110	225				112								
inch-lb	4	18,11	17,99	3,94	5,63	10,83				452								
mm-Kg	100	460	457	100	143	275				205								
inch-lb	6	24,13	24,02	5,91	7,95	11,61	181/09			955								
mm-Kg	150	613	610	150	202	295				433								
inch-lb	8	29,13	29,02	7,91	9,25	15,08	kr			1323								
mm-Kg	200	740	737	201	235	383				600								
inch-lb	10	33,11	32,99	9,92	11,42	16,26	286/07			2028								
mm-Kg	250	841	838	252	290	413				920								
inch-lb	12	38,11	37,99	11,93	16,34	20,08				2917								
mm-Kg	300	968	965	303	415	510				1323								
inch-lb	14	40,87	40,51	12,68	17,32	20,08				3785								
mm-Kg	350	1038	1029	322	440	510				1717								
inch-lb	16	44,88	44,49	14,69	14,96	20,87	286/07			5181								
mm-Kg	400	1140	1130	373	380	530				2350								
inch-lb	18	48,50	47,99	16,65	19,29	22,64				7518								
mm-Kg	450	1232	1219	423	490	575				3410								
inch-lb	20	52,52	52,01	18,54	23,74	24,80				9678								
mm-Kg	500	1334	1321	471	603	630				4390								
inch-lb	22	*	*	*	*	*				*								
mm-Kg	550	*	*	*	*	*				*								
inch-lb	24	61,73	60,98	22,44	42,91	27,17				16028								
mm-Kg	600	1568	1549	570	1090	690				7270								
inch-lb	26	65,87	65,00	24,29	44,49	29,53				19169								
mm-Kg	650	1673	1651	617	1130	750				8695								
inch-lb	28	69,88	69,02	26,18	26,18	33,31	perar			21385								
mm-Kg	700	1775	1753	665	665	846				9700								
inch-lb	30	74,88	74,02	28,03	27,56	35,12	kr			26235								
mm-Kg	750	1902	1880	712	700	892				11900								
inch-lb	32	80,87	80,00	29,92	29,53	37,80	185/11			33069								
mm-Kg	800	2054	2032	760	750	960				15000								
inch-lb	34	86,14	85,00	31,81	59,06	38,98				38735								
mm-Kg	850	2188	2159	808	1500	990				17570								
inch-lb	36	91,14	90,00	33,66	61,93	41,14				45636								
mm-Kg	900	2315	2286	855	1573	1045				20700								

"All the above dimensions and weights could be subjected to changes by Perar SpA without any notification, due to engineering activities. Therefore, please consult the factory for confirmation on the above data as well as for other dimensions and weights not reported in the table".



ASME Class 1500# Top Entry Body Full Bore

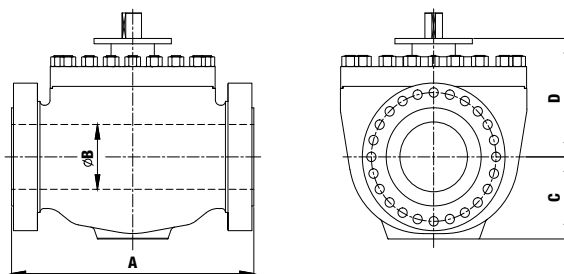

	SIZE	A(RF)	A(BW)	B	C	D	NOTE			WEIGHT							
inch-lb	2	14,61	14,49	1,93	3,27	8,27				121							
mm-Kg	50	371	368	49	83	210				55							
inch-lb	3	18,62	18,50	2,91	5,43	9,45	050/11			342							
mm-Kg	80	473	470	74	138	240				155							
inch-lb	4	21,61	21,50	3,94	6,02	11,42				606							
mm-Kg	100	549	546	100	153	290				275							
inch-lb	6	27,99	27,76	5,67	9,25	11,81				1360							
mm-Kg	150	711	705	144	235	300				617							
inch-lb	8	33,11	32,76	7,56	10,04	15,20	050/11			2513							
mm-Kg	200	841	832	192	255	386				1140							
inch-lb	10	39,37	39,02	9,41	13,19	15,75				3192							
mm-Kg	250	1000	991	239	335	400				1448							
inch-lb	12	45,12	44,49	11,30	13,82	19,17	050/11			4438							
mm-Kg	300	1146	1130	287	351	487				2013							
inch-lb	14	50,24	49,49	12,40	18,11	21,46				5769							
mm-Kg	350	1276	1257	315	460	545				2617							
inch-lb	16	55,39	54,49	14,17	19,29	22,05				8591							
mm-Kg	400	1407	1384	360	490	560				3897							
inch-lb	18	61,38	60,51	15,98	20,67	23,23				11431							
mm-Kg	450	1559	1537	406	525	590				5185							
inch-lb	20	66,38	65,51	17,87	24,69	25,79				14683							
mm-Kg	500	1686	1664	454	627	655				6660							
inch-lb	22	*	*	*	*	*				*							
mm-Kg	550	*	*	*	*	*				*							
inch-lb	24	77,64	*	21,50	24,06	33,19	050/11			25574							
mm-Kg	600	1972	*	546	611	843				11600							



ASME Class 2500# Top Entry Body Full Bore

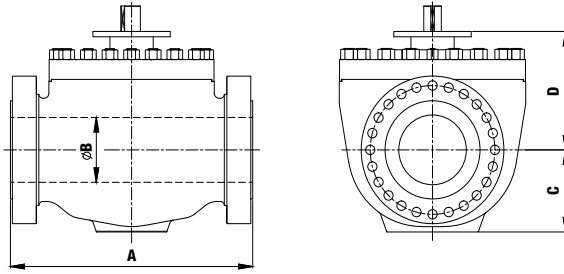

	SIZE	A(RF)	A(BW)	B	C	D	NOTE			WEIGHT								
inch-lb	2	17,87	17,76	1,65	3,74	8,27				269								
mm-Kg	50	454	451	42	95	210				122								
inch-lb	3	22,99	22,76	2,44	4,92	9,45				551								
mm-Kg	80	584	578	62	125	240				250								
inch-lb	4	26,89	26,50	3,43	6,30	11,81				1032								
mm-Kg	100	683	673	87	160	300				468								
inch-lb	6	36,50	35,98	10,63	9,53	13,78				2094								
mm-Kg	150	927	914	270	242	350				950								
inch-lb	8	40,87	40,24	7,05	11,42	16,54				3247								
mm-Kg	200	1038	1022	179	290	420				1473								
inch-lb	10	50,87	50,00	8,78	13,98	19,69				5836								
mm-Kg	250	1292	1270	223	355	500				2647								
inch-lb	12	56,89	55,98	10,43	17,13	23,03				9319								
mm-Kg	300	1445	1422	265	435	585				4227								

"All the above dimensions and weights could be subjected to changes by Perar SpA without any notification, due to engineering activities. Therefore, please consult the factory for confirmation on the above data as well as for other dimensions and weights not reported in the table".



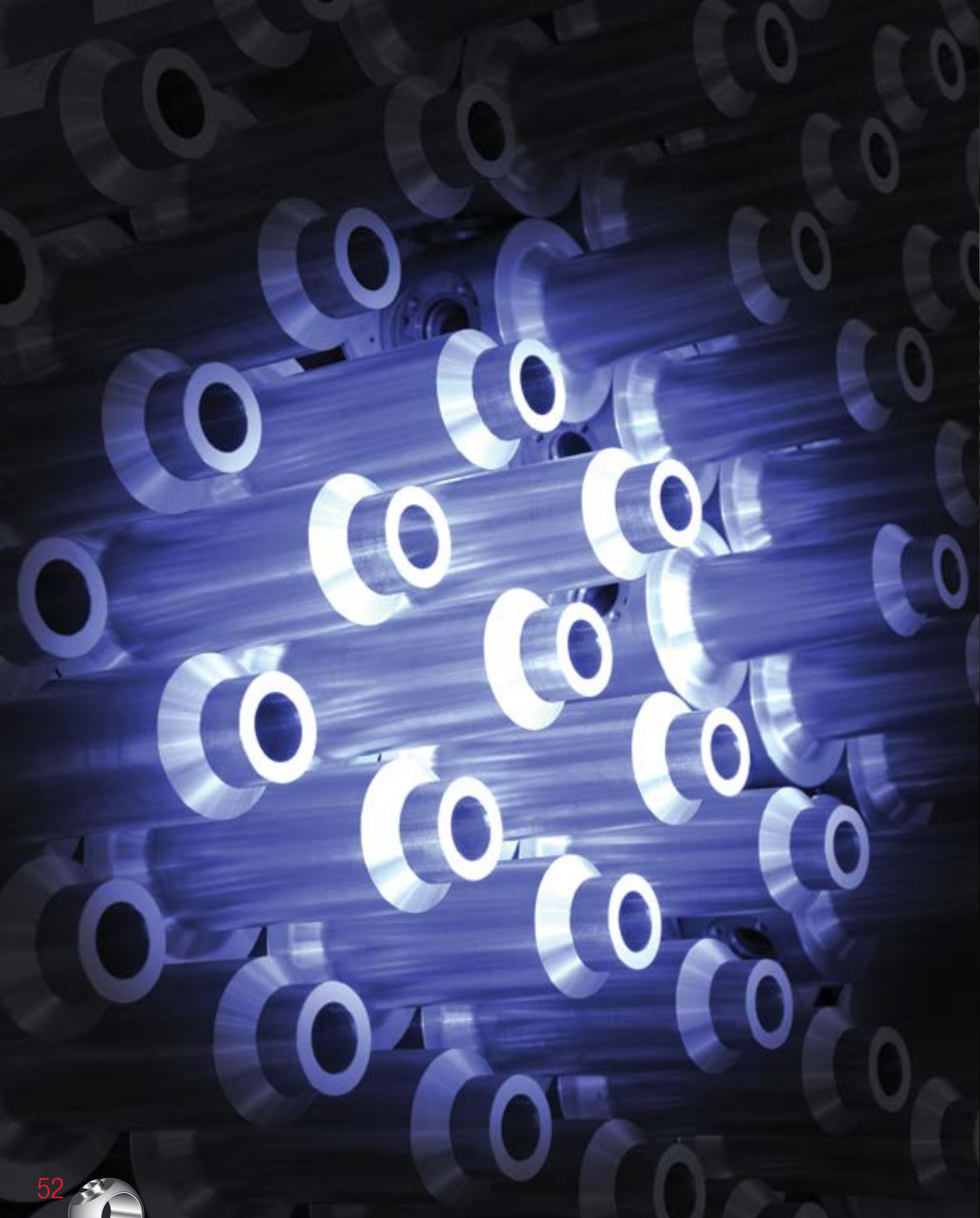



Perar

Custom Made

... to suit your requirements!



Perar

Perar S.p.A.

Via Grigna, 37

20027 Rescaldina, (Milano) - Italy

Phone: +39.0331.465208

Telefax: +39.0331.465731

E-mail: info@trpsrl.it

Website: www.perar.it

Perar USA

Perar USA Inc.

13831 Northwest Freeway, Suite 635

Houston TX 77040 - USA

Phone: 281-459-0771

Telefax: 281-886-7787

E-mail: info@perarusa.com

For Inquires contact :

T.R.P. S.r.l.

Via Grigna, 37

20027 Rescaldina, (Milano) - Italy

Phone: +39 0331 576710 a.s.

Telefax: +39 0331 578802

E-mail: info@trpsrl.it

Perar